

Lyra Pro Series

Interactive Flat Panel Display

User Manual

V1.0

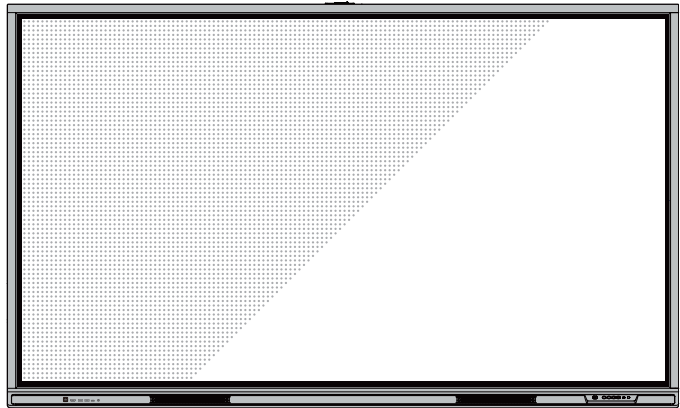

newline

Contents

.....

About This Document	01
Safety Instruction	02
1.Overview	06
1.1 Introduction	06
1.2 Parts	06
1.3 Ports	08
1.4 Front Buttons	10
1.5 Remote Control	11
2.Installation Guide	12
2.1 Safety Precautions.....	12
2.2 Installation Precautions.....	12
2.3 Installation.....	14
2.4 Installing the OPS (Optional).....	16
2.5 Installing the Wi-Fi Module.....	16
2.6 Installing the Camera(Optional).....	17
2.7 Installing the SDM-S (Not included).....	18
2.8 Installing Newline Assistant.....	18
2.8.1 Introduction	18
2.8.2 Installation	18
3.Getting Started	19
3.1 Power On.....	19
3.2 Power Off.....	19
3.3 Calibration	20
4.Operating	23
4.1 Profile Logon.....	23
4.2 Home.....	23
4.3 Whiteboard.....	28
4.3.1 Whiteboard Functions.....	30
4.3.2 Whiteboard Setting.....	36
4.3.3 Page Operations.....	38
4.3.4 Annotation	40
4.4 Application.....	41
4.4.1 Google App Store.....	41

4.4.2 Newline Display Management+	42
4.4.3 Newline Cast+	42
4.4.4 Files	43
4.4.5 Visualizer	43
4.4.6 Vote	44
4.5 Extended Functions	47
4.5.1 Capture	47
4.5.2 Sources	48
4.5.3 Quick Setting Menu	48
4.5.4 Automatically Power Off	49
4.6 Settings	49
4.6.1 Network & Internet	50
4.6.2 Connected devices	50
4.6.3 Apps	51
4.6.4 Notifications	51
4.6.5 Storage	52
4.6.6 Sound and vibration	52
4.6.7 Display	53
4.6.8 Wallpaper & Style	54
4.6.9 Security	54
4.6.10 Location	55
4.6.11 Passwords & Account	55
4.6.12 Tool Bar	55
4.6.13 Input and Output Setting	55
4.6.14 Power Setting	56
4.6.15 Screen Eye Filters	57
4.6.16 Google	58
4.6.17 System	58
4.6.18 About Tablet	61
5 Serial Port Control	63
6 FAQs & Troubleshooting	69
7 Specifications	71
8 More Information	75

Welcome to the world of Newline.

Thank you for choosing the Lyra Pro series Interactive Flat panel display. Please use this document to get the most out of your screen.

This device complies with part 15 of the FCC Rules. Operation is subject to the following two conditions: (1) This device may not cause harmful interference, and (2) this device must accept any interference received, including interference that may cause undesired operation.

NOTE 1: This equipment has been tested and found to comply with the limits for a Class B digital device, pursuant to part 15 of the FCC Rules. These limits are designed to provide reasonable protection against harmful interference in a residential installation. This equipment generates, uses, and can radiate radio frequency energy and, if not installed and used in accordance with the instructions, may cause harmful interference to radio communications. However, there is no guarantee that interference will not occur in a particular installation. If this equipment does cause harmful interference to radio or television reception, which can be determined by turning the equipment off and on, the user is encouraged to try to correct the interference by one or more of the following measures:

- Reorient or relocate the receiving antenna.
- Increase the separation between the equipment and receiver.
- Connect the equipment into an outlet on a circuit different from that to which the receiver is connected.
- Consult the dealer or an experienced radio/TV technician for help.

NOTE 2: Any changes or modifications to this unit not expressly approved by the party responsible for compliance could void the user's authority to operate the equipment.

The symbol of the crossed out wheeled bin indicates this product should not be placed in municipal waste. Instead, dispose of waste equipment by taking it to a designated collection point for electrical and electronic equipment recycling.



Energy Star Compliance



Signage Displays with Plug-in Module.

As an ENERGY STAR Partner, Newline Interactive Inc., has followed the EPA's enhanced Product qualification and certification process to ensure that the products marked with the ENERGY STAR logo are ENERGY STAR qualified per the applicable ENERGY STAR guidelines for energy efficiency. The logo appears on the pen tray near front connections on all ENERGY STAR qualified Signage Displays.

The ENERGY STAR program for Signage Displays was created by EPA to promote energy efficiency and reduce air pollution through more energy-efficient equipment in offices, classrooms and factories. One way that a product achieve this goal is by using a power management feature to reduce power consumption when the product is not in use.

For TT-5523QA, TT-6523QA, TT-7523QA, TT-8623QA and TT-9823QA, sleep mode can be initiated in a couple different ways. Users can take the action of pressing the power button on the panel, or a remote command can be sent via RS232. The panel will also go into sleep mode without user action after one hour of inactivity.

TT-5523QA, TT-6523QA, TT-7523QA, TT-8623QA and TT-9823QA can exit sleep mode by the user pressing the power button, or by the proximity sensors detecting a user's presence, or through a remote command via RS232. In the event of a proximity detection, the panel will transition from sleep mode to another low power mode, STAND BY.

In the event that brightness settings or power mode settings are changed by the user, energy consumption of the panel may increase beyond the limits required for ENERGY STAR certification.

Additional information on the ENERGY STAR program and its environmental benefits are available on the EPA ENERGY STAR Power Management website at <http://www.energystar.gov/powermanagement>.

Additional information on the ENERGY STAR program and its environment benefits are available on the EPA ENERGY STAR website at <http://www.energystar.gov>

For production, above information will need to be available for the Energy Star V8 build from 27th January 2020.

For TT-5523QA, TT-6523QA, TT-7523QA and TT-8623QA, Manufacturer-reported maximum luminance L_{Max} Reported is 400cd/m².





For TT-9823QA, Manufacturer-reported maximum luminance L_{Max} Reported is 420cd/m².

About This Document

.....





This document describes multiple functions, instructions, and notes about the product.

Symbols are used in this document to indicate operations that need particular attention. The symbols are defined as follows:

 NOTE	Provides additional information to supplement operation in the main text.
 TIP	Provides tips for operation.
 CAUTION	Indicates a potentially hazardous situation that, if not avoided, could result in equipment damage, data loss, performance deterioration, or unanticipated results.
 WARNING	Indicates a hazard with risk that, if not avoided, could result in death or injury.

Safety Instruction

For your safety, please read the following instruction before you use the product. Serious injury or property damage may be caused by improper operations. Do not try to repair the product on your own.

 WARNING	
	<p>Disconnect the product from the power supply immediately if major failures occur.</p> <p>Major failures include the following:</p> <ul style="list-style-type: none"> • If smoke, a peculiar smell or an abnormal sound is discharged from the product. • No image or sound is displayed, or the image error occurs. <p>In the preceding scenarios, do not continue to use the product. Disconnect power supply immediately and contact professional staff for troubleshooting.</p>
	<p>Do not drop any liquids, metal or anything combustible onto the product.</p> <ul style="list-style-type: none"> • If any liquids or metal are dropped onto or into the product, power off the product and disconnect the power supply. Then contact professional staff for solutions. • Pay attention to children when they are close to the product. <p>Put the product on a stable surface.</p> <p>An unstable surface includes, and is not limited to, an inclined plane, a shaky stand, desk or platform, that might cause the product to turnover and be damaged.</p>
	<p>Do not open the panel or change the product on your own.</p> <p>High voltage components are installed in the product. When you open the panel, high voltage, electric shock, or other dangerous situations may occur. If inspection, adjustment, or maintenance is required, contact the local distributor for help.</p>
	<p>Use the provided power supply.</p> <ul style="list-style-type: none"> • To prevent the product from being damaged, do not use any types of power cables other than the one provided with the product. • Use a three-wire socket and ensure that it is properly grounded. • Pull out the power plug from the socket if the product is not used for a long period. <p>Clean the power plug regularly.</p> <ul style="list-style-type: none"> • Fire or electric shock may be caused if the product is powered on while you are cleaning. • Pull out the power plug before cleaning it with a dried cloth.

WARNING



Do not put items on the top of the product.

- Do not put items, such as a container for liquid (a vase, flowerpot, cosmetics or liquid medicine) on the top of the product.
- If any water or liquid is spilled on the product, the product may short circuit and cause fire or electric shock.
- Do not walk on or hang any items on the product.



Do not install the product in an improper place.

- Do not install the product in humid places, such as the bathroom, the shower room, near windows, or outdoor environments that experience rain, snow, or other harsh weather. Avoid installation near hot spring vapor. The preceding environments may cause faults in the product or electric shock under extreme conditions.
- Do not put an exposed fire source, such as a lit candle, on the product.



Pull out the power supply during thunderstorms.

- Do not touch the product during a lightning storm, you may experience an electric shock.
- Install or place components that supply high enough voltage to cause personal injury out of the reach of children.



Do not touch the power cable with wet hands.

CAUTION



Do not install the product in high temperature environments.

- Do not install the product near a heat source, such as a radiator, a heat reservoir, a stove or other heating products.
- Do not expose the product to direct sunlight, which may cause high temperatures and subsequent faults in the product.



When transporting the product:

- Pack the product for transport or maintenance by using the cartons and cushioning material provided with the product.
- Move the product vertically during transport. The screen or other components are easily broken if the product is moved in an improper way.
- Before you move the product, disconnect all external connections and separate all topple preventing products. Move the product carefully to prevent it from being hit or squeezed, especially the screen, which may cause injury if broken.

CAUTION



Do not cover or block up any vents on the product.

- Any overheated components may cause fire, damage the product, and shorten the service life.
- Do not lay the product down in a way where the venting surface will be covered.
- Do not install the product on carpet or cloth.
- Do not use a cloth such as table cloth to cover the product.

Keep the product away from the radio.

The product complies with the international EMI standard to prevent radio interference. However, interference may still exist and cause noise in the radio. If noise occurs in the radio, try the following solutions.

- Adjust the direction of the radio antenna to avoid the interference from the product.
- Keep the radio away from the product.

If the screen glass is broken or falls off.

- Keep all personnel 10 feet away from the screen to ensure safety.
- Do not perform any installation or disassembly while the screen glass is broken or has fallen off.



Use the battery correctly.

- Galvanic corrosion, electric leakage, and even fire may be caused by improper battery usage.
- It is recommended to use the designated type of battery and install the battery by the correct electrodes (positive and negative).
- Do not install and use a new battery with a used one.
- Take out the battery if the remote control is not used for a long period.
- Do not expose the battery to overheated environments, such as sunlight and other heat sources.
- Dispose of the used battery based on your local regulations.

Do not damage the power cable.

- Do not damage, change, twist, bend, or forcibly drag the power cable.
- Do not put weights (such as the product itself) on the power cable.
- Do not forcibly drag the cable when you pull out the power plug. If the power cable is damaged, please contact the local distributor to repair or replace it.
- The power cable in the accessory box is for this product only. Do not use it on other products.

CAUTION



Additional advice:

- Use the product in an environment with comfortable lighting. It is harmful to your eyes to watch in a too bright or too dark environment.
- Relax your eyes watching for a period of time.
- Keep sufficient distance from the product to protect your eyes and prevent eyestrain. The recommended viewing distances are as follows, TT-5523QA /TT-6523QA: 2750mm, TT-7523QA: 2910mm, TT-8623QA: 3360mm, TT-9823QA: 3827mm.
- Adjust the volume to an appropriate level, especially at night.
- Excessive sound pressure from ear-/headphones can cause hearing damage/ hearing loss.
- Adjustment of the volume control as well as the equalizer to other settings than the center position may increase the ear-/headphones output voltage and therefore the sound pressure level.
- The use of factors influencing the ear-/headphones output other than those specified by the manufacturer (e.g. operating system, equalizer software, firmware, driver) may increase the ear-/headphones output voltage and therefore the sound pressure level.
- The use of ear-/headphones other than those specified by the manufacturer may lead to heightened sound pressure level.
- Use amplifier equipment as the audio input source with caution. If you must use amplifier equipment, the input power should not exceed the maximum of speaker power. Otherwise, the speaker can become overpowered and damaged.

About USB port.

Front USB ports and rear USB 3.0/USB 2.0 ports switch connections based on signal sources. If the current signal source is reading the data from an external product connecting to the port, please switch the signal source after the data reading is complete. Otherwise, the data or product may be damaged.

1

Overview

1.1 Introduction

Take collaboration to the next level with the Lyra Pro series interactive display.

Increase productivity and collaboration across the board with a display that uses advanced touch technology.

Each product can be customized to fit your needs. The non-proprietary nature lets you use the software you prefer, take notes on local files, wirelessly cast to the screen from smaller devices, run your favorite apps, and view multimedia files, all while making your experience better than before.

The newline's 4K Ultra High-Definition LED screen also provides a fluid writing experience. Annotate over anything on the screen, whether in the embedded whiteboard or while using any other device. IntelliTouch automatically identifies pen thickness and color, saving your time

1.2 Parts

- Front View

55/65/75/86/98inch:

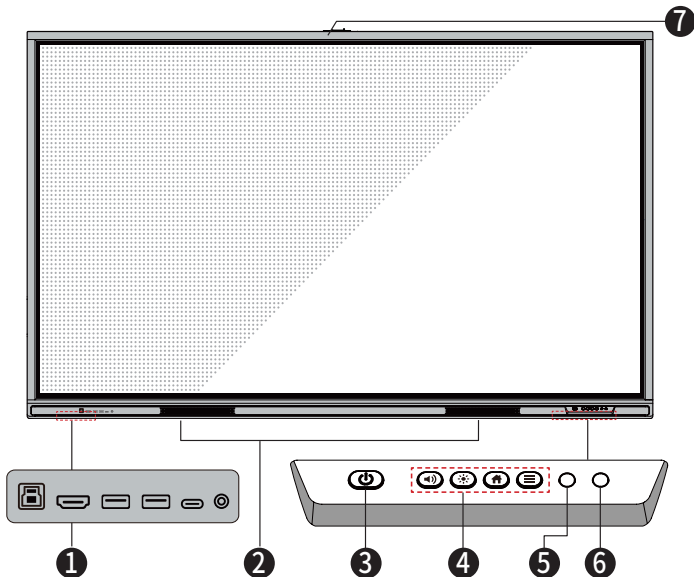

- Rear View

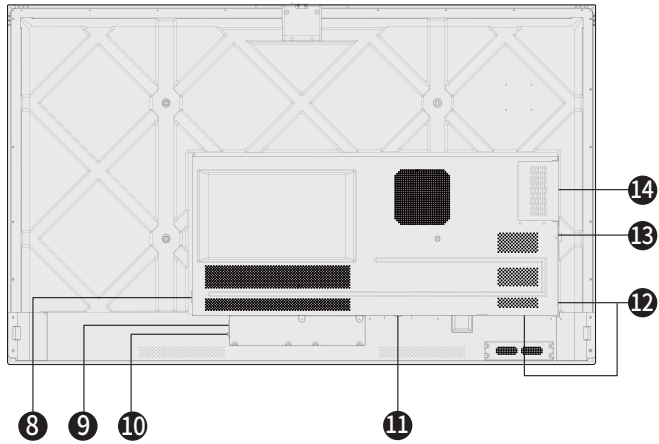

①	Front Ports	⑧	Power Output Plug
②	Speakers	⑨	Power Supply Plug
③	Power On/Off	⑩	Power Switch
④	Front Buttons	⑪	SDM-S Slot
⑤	Remote Control Receiver	⑫	Rear Ports
⑥	Light Sensor	⑬	Wi-Fi Module
⑦	Camera Port	⑭	OPS Port

📖 Notes

- SDM-S is Smart Display Module Small.
- The product images shown are for illustration purposes only and may not be an exact representation of the product.

1.3 Ports

CAUTION

- Front USB ports and rear USB 3.0/USB 2.0 ports switch connections based on signal sources. If the current signal source is reading the data from an external product connecting to the port, please switch the signal source after the data reading is complete. Otherwise, the data or product may be damaged.
- For USB use, USB 2.0 provides up to 500mA whereas USB 3.0 provides up to 900mA of power. Please make sure the USB flash drive is formatted to FAT32 before inserting into the panel.
- Please use the supplied cable in the accessory box or the HDMI association certified shielded cable to better ensure the signal quality.
- While HDMI and Display Port offer support for cables of varying lengths, the maximum cable length that Newline recommends for optimal performance is 3 meters (10 feet) for HDMI and 1.8 meters (around 6 feet) for Display Port. Using cable longer than recommended length may cause data loss and a negative impact to display quality.

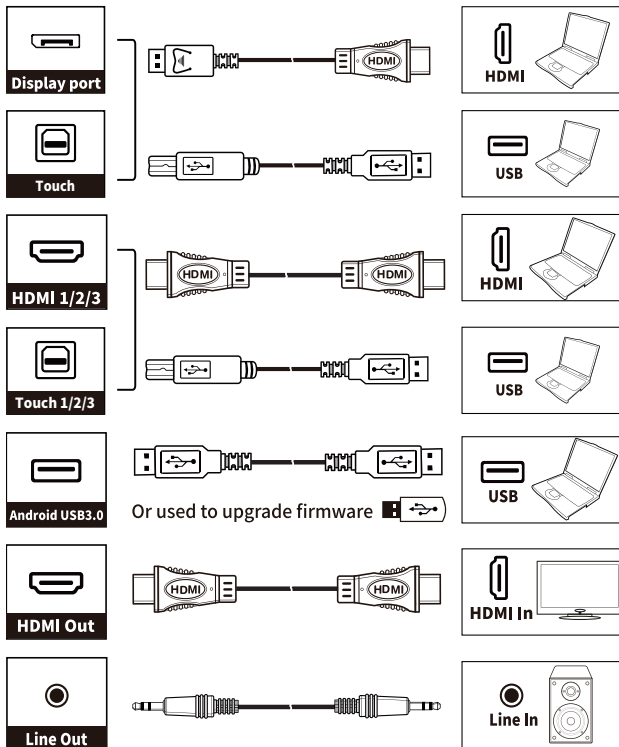

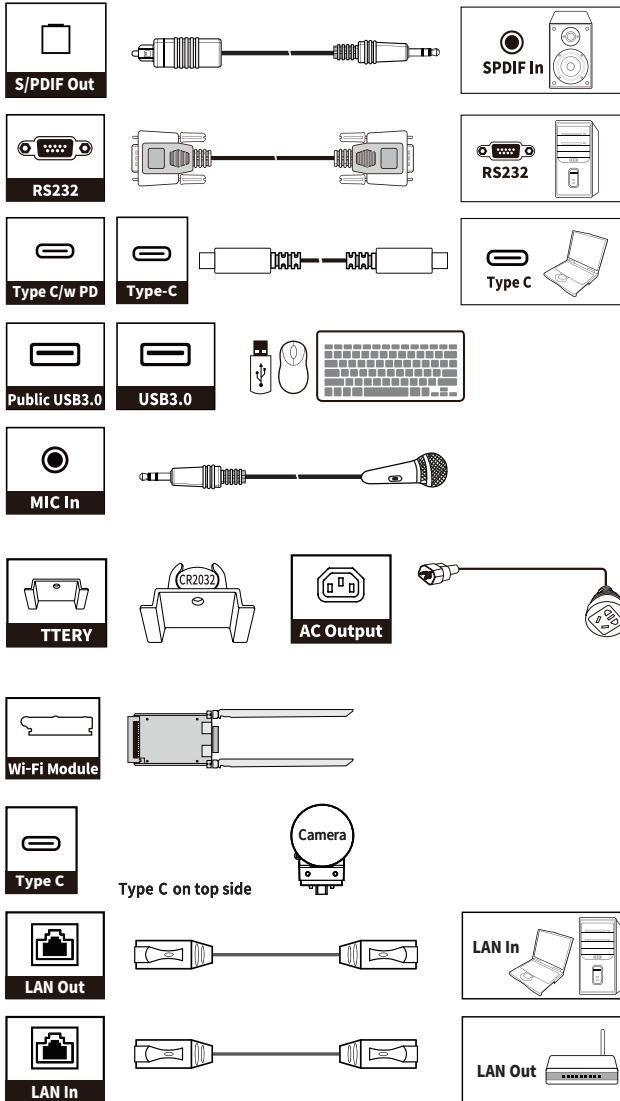





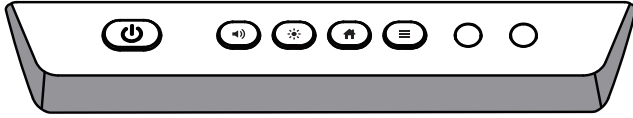

⚠ WARNING

The rear power output port supplies 180W (maximum) power. Please contact Newline to purchase the power AC adapter for powering external devices. Please do not connect any products which require power than listed. Doing so may cause injury or damage to the panel.

1.4 Front Buttons



Buttons	Operations	Functions
	Short press	Power on • Solid white color : Display is on and working. Sleep mode • The red and white lights flicker alternately: Display enter Sleep mode.
	Long press for more than 2 seconds	Power off • Solid red color : Display is in shut down mode.
	Short press	Adjust the Volume.
	Long press for 5 seconds	Enable or disable the touch function. Notes: When the touch function is disabled, the Android system, external sources and multi-user channels will be in no-touch mode. If you tap the screen, it will display "The touch function is locked!".
	Short press	Adjust the Brightness
	Short press	Go to the home page.
	Short press	Open the Quick Setting menu.
	Long press for 5 seconds	Activate/Exit the power button Lock Function.

Note













- Press **Volume + >Volume + >Volume - >Volume - > Left > Left > Right > Right** buttons on the Remote control to turn on/off the touch function.
- The power button on the front panel will be locked if you activate the power button lock. Long press  button for 5 seconds to exit the lock.

1.5 Remote Control

CAUTION

Carefully read the following instructions before using the remote control to avoid possible faults:

- Do not drop or damage the remote control.
- Do not spill water or other liquids on the remote control.
- Do not place the remote control on a wet object.
- Do not place the remote control directly under sunlight or near a heat source.

Buttons	Operations
	Power On/Off
	Go to the Home Page
	Directional Pad
	Confirm/OK
	Press once to freeze the current screen. Press again to exit freeze function
	Enter the Source Selection Page
	Return to Previous/Exit
	App switcher
	<ul style="list-style-type: none"> • Open the Quick Setting menu on the embedded operating system. • Open the menu in Windows system.
	Take a Screenshot
	Press once to decrease the volume, long press to decrease the volume continuously
	Mute/Unmute Audio
	Press once to increase the volume, long press to increase the volume continuously

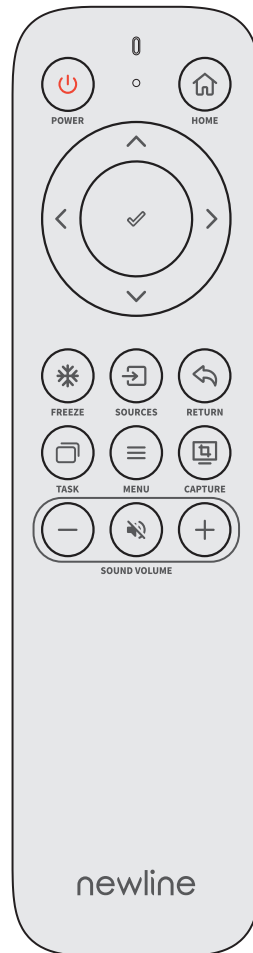

2

Installation Guide

2.1 Safety Precautions

• Installation Environment



• Installation Direction

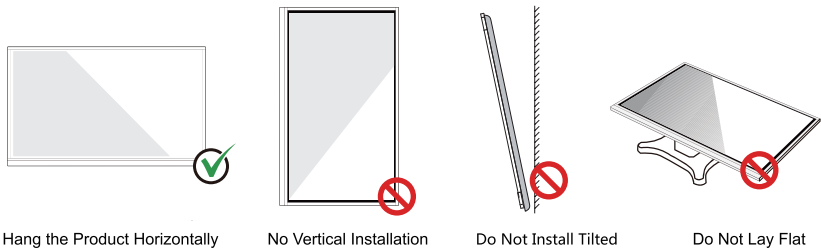

2.2 Installation Precautions

• Weight Loading

Weight of the product: 55 inch: 29.5 kg/65 lb, 65 inch: 39 kg/85.9 lb,
 75 inch: 51 kg/112.4 lb, 86 inch: 63 kg/138.8 lb,
 98 inch: 108 kg/238 lb.

- When using a mobile stand, ensure that the weight of the product is less than the loading capacity of the mobile stand.

- When using the wall-mount bracket, ensure that the wall can support the weight of the product. We recommend that the wall surface be reinforced and have a loading capacity 4 times of the weight of the product. Consult a professional installer for wall-mount installation.
- Attaching the VESA Mounting Bracket. This apparatus is intended to be supported by a GS Listed wall-mount bracket.

Note

The company does not undertake relevant legal responsibility for any problems caused by improper operation if the third party mobile stand, or wall-mount bracket is beyond the scope of the product

- Do not install the product where it might be hit by an opening or closing door.

Vertical installation

When installing the panel, try to keep the panel vertical. An excessive tilt angle may cause damage to the glass or other internal components.

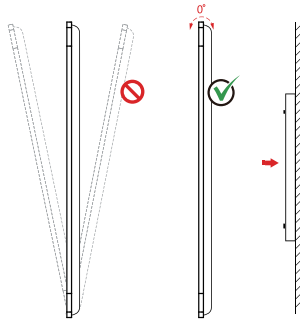

Note

For any problem, please contact our support desk. Our company is not responsible for any damage or losses incurred by users if the users fails to follow the instructions

Ventilation

Ensure adequate ventilation and/or an air conditioned environment. We recommend keeping certain distances from the side of the product to the wall or panels. Ventilation requirements are shown in following figure:

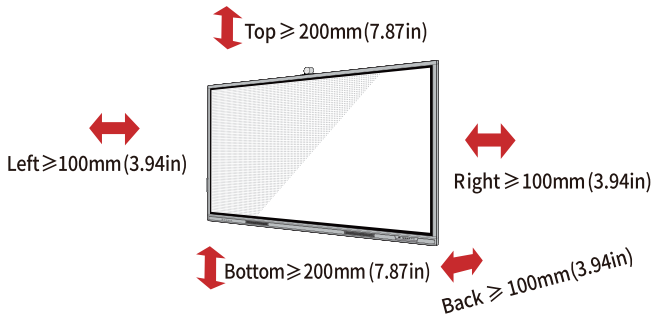

2.3 Installation

The dimensions of the four bracket mounting holes on the back panel are VESA MIS-F compliant:

98 INCH: 800 x 600 mm/31.50 x 23.62 in;

86INCH or 75INCH: 800 x 400 mm/31.50 x 15.75 in;

65INCH: 600 x 400 mm/23.62 x 15.75 in;

55INCH: 400 x 400 mm/15.75 x 15.75 in.

Use metric M8 screws with a length of 10 mm to 15 mm (0.40 to 0.59 in) to secure the touchscreen to the mounting system. Dimensions of the mounting holes on the back panel are shown on the following figure:

Note

Consult a professional installer to install the display product.

55"

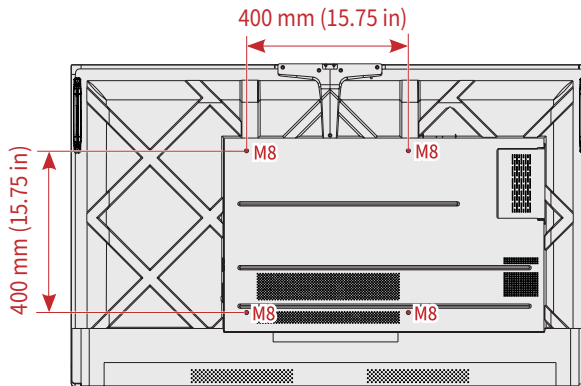

65"

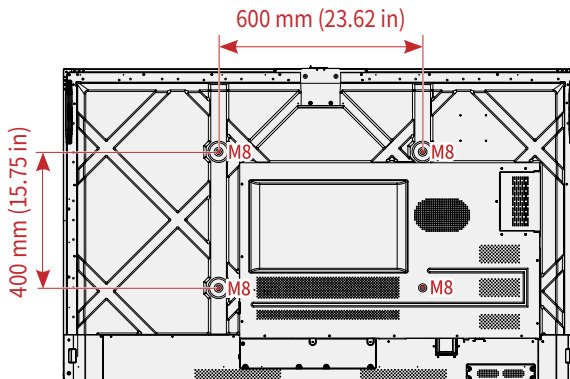

75"/86"

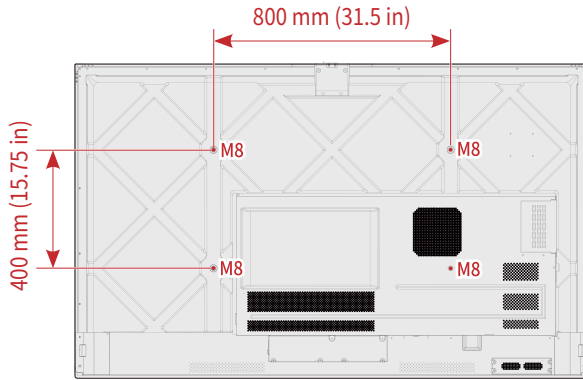

98"

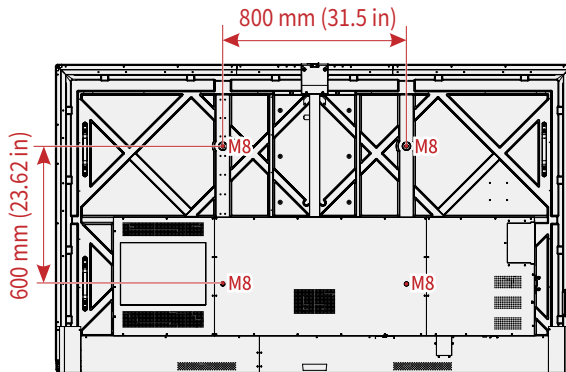

2.4 Installing the OPS (Optional)

CAUTION

The OPS does not support hot plugging. Therefore, you must insert or remove the OPS when the display is powered off. Otherwise, the display or OPS may be damaged.

You will need to purchase the OPS separately. Perform the following steps to install the OPS

Step 1: Unscrew the M4 screws by hand to remove the OPS protective cover.

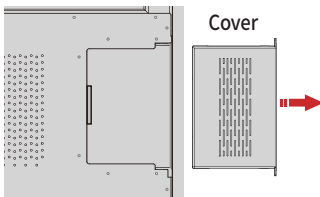

Step 2: Push the OPS into the OPS port on the rear of the panel until firmly seated, using the M4 screws to secure the OPS.

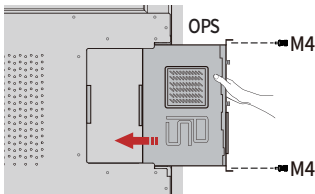

2.5 Installing the Wi-Fi Module

CAUTION

Wi-Fi Module does not support hot plugging. Therefore, you must insert or remove the Wi-Fi Module when the display is powered off. Otherwise, the display or Wi-Fi Module may be damaged.

Perform the following steps to install the Wi-Fi Module

Step 1: Unscrew the 2 screws on the Wi-Fi Module port and remove the shielding cover.

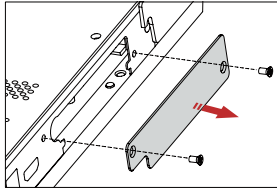

Step 2: Insert the Wi-Fi Module into the port on the rear of the panel until firmly seated, using the 2 screws to secure it.

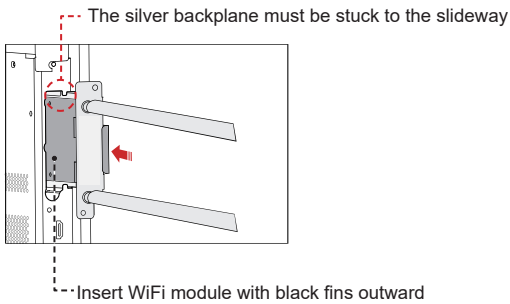
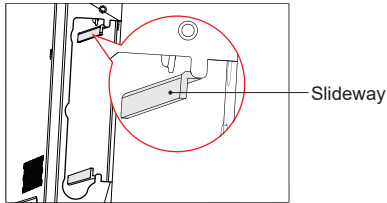

2.6 Installing the Camera(Optional)

The camera is put in accessory box with an independent package, please install it onto panel referring to following steps. Use two screws along with the camera to fix it. Remove the silicone cover from the middle port on the top of the panel display, then insert the camera. Install 2 fixing screws for secure purpose. Remove the front cover and start using.

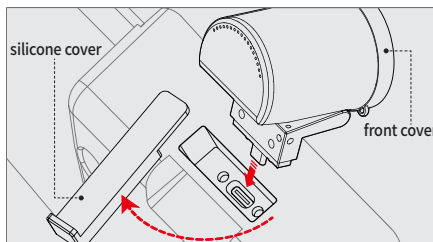

2.7 Installing the SDM-S (Not included)

CAUTION

The SDM-S does not support hot plugging. Therefore, you must insert or remove the SDM-S when the display is powered off. Otherwise, the display or SDM-S may be damaged.

Currently we don't provide SDM-S, but if you have a SDM-S to use, please install referring to the following steps.

Step 1 Unscrew the 2 screws on the SDM slot and remove the shielding cover.

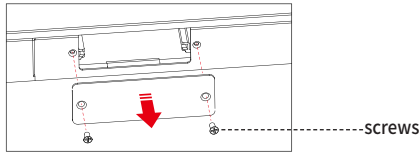

Step 2 Insert the SDM-S into the port on the rear of the panel until firmly seated, using the 2 screws to secure it.

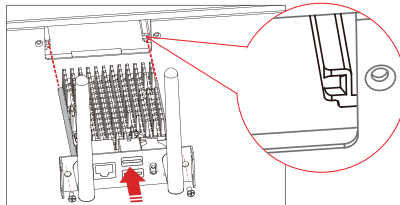

Note

Please install SDM-S first before you hang panel on the wall.

2.8 Installing Newline Assistant

2.8.1 Introduction

The Newline Assistant agent is a tool used as a bridge between the embedded operating system and the OPS. It helps add Windows software shortcut to the Home Page, as well as to protect USB data when switching between sources.

Therefore we strongly recommend users install the Newline Assistant after installing the OPS.

2.8.2 Installation

Step 1 Install select the OPS correctly (See "Installing the OPS (Optional)").

Step 2 On the **Home Page**, tap **OPS** and the source will switch to the Windows operating system.

Step 3 Visit our website at www.newline-interactive.com and choose **Products** > **Lyra Pro series** > **download** to download the Newline Assistant installation package.

Step 4 Install the [Newline Assistant](#) as instructed.

3

Getting Started

3.1 Power On

Step 1: Ensure the power cable is fully seated into the panel and wall outlet before powering on the panel. Please confirm your wall outlet supports a power range of 100V to 240V with frequency at 50 Hz/60 Hz ± 5% and is fully grounded.

Note



The power outlet should be installed near the equipment and should be easily accessible.

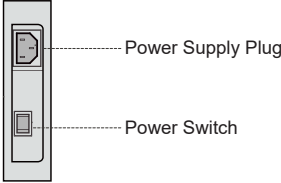

Step 2: Flip the power switch located on the side of the product to “I”.



Step 3: Press the power button  on the front control panel or  on the remote control.

3.2 Power Off

Step 1: Press the power button  on the front panel or the power button  on the remote control to enter sleep mode.

Step 2: Long press the power button  on the front panel or the power button  on the remote control, The **Warning** dialog box will be displayed as shown in the following figure.

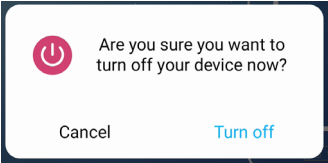

Step 3: In the **Warning** dialog box, tap **Cancel** to return to working mode. Tap **Turn off** to turn off the panel, and the power indicator will turn to red.

Step 4: If you want to completely turn off the product, turn off the rocker switch behind the panel (next to the power socket) and unplug the power cord.

Note

- If an OPS is installed, the OPS and the screen will simultaneously powered off when the power is shutoff.
- Please properly shut down the panel before disconnecting the power source or it may cause damage. Accidental power failure may cause damage to the panel.
- Do not repeatedly turn the power on & off in a short period of time as it may cause malfunction.

3.3 Calibration

If the cursor position has a big deviation from the actual touch point, calibration is used to eliminate the deviation. Calibration is required in the following scenarios:

- The OPS is used.
- A computer is connected through the HDMI or Display Port interface.

Note

Interface operation on the embedded operating system does not need positioning. External products with Microsoft Windows 7 or later versions will require positioning.

If the positioning is not correct, perform the following operations to calibrate again. The following takes Windows 10 as an example:

Step 1: Ensure that the HDMI or DP interface and external products are connected properly.

Step 2: Select the corresponding Windows signal from the signal source menu. The Windows page will be displayed.

Step 3: Select **Tablet PC Settings** on the **Control Panel** page.

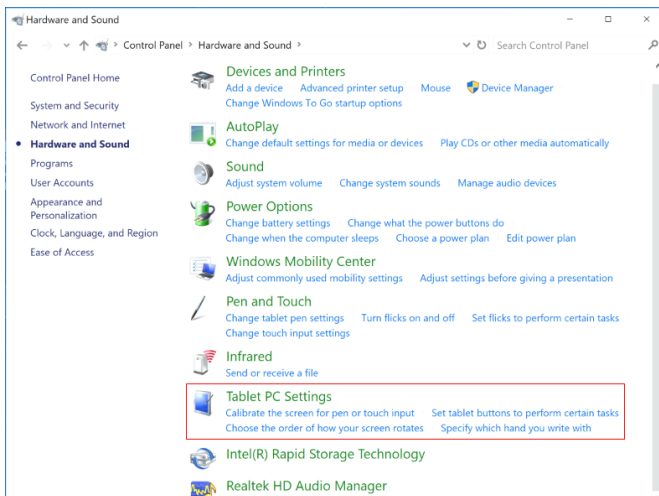

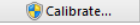
Step 4: Select “  ” in the Tablet PC Settings window.

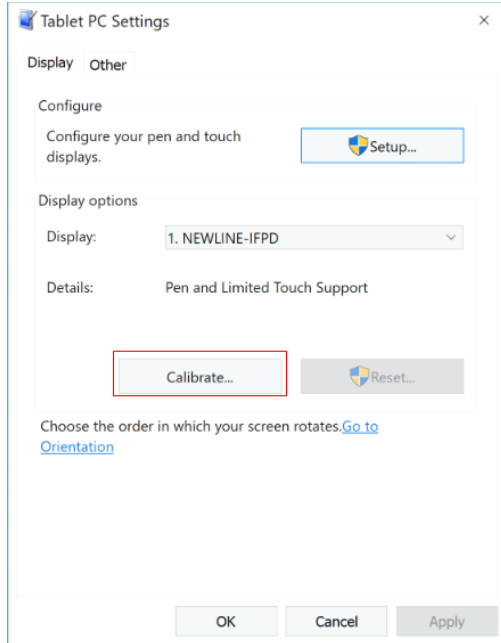

Step 5: Select **Touch input** from the option and start calibration.

Step 6: Use your finger or a pencil to click and hold the center of the flickering cross + . Do not release until + moves to the next positioning point. Complete the calibration process as instructed.

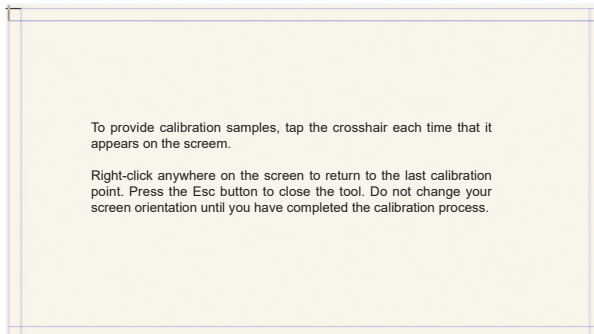

Step 7: After the calibration is complete, the **Digitizer Calibration Tool** dialog box will be displayed. Click **Yes** to save calibration data.

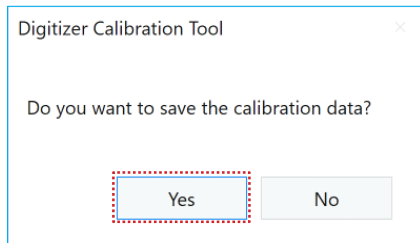

 **TIP**

- To ensure writing accuracy, use the pencil or stylus included with the product for proper positioning.
- Positioning errors may cause failure of touch functions of the display. In that case, please perform calibration again.

Step 8: The **Tablet PC Settings** dialog box will be displayed again. Tap **OK**. The calibration will be complete.

4

Operating

4.1 Profile Logon

When you set the screen lock in **Settings>Security>Screen Lock**, you need to verify the lock screen code after each boot.

Method	Operation
Swipe	Swipe the screen to unlock
Pattern	Draw an unlock pattern, the pattern need connect at least 4 dots.
Pin	Enter the pin code, the pin must be at least 4 digits.
Password	Enter the password, the password must be at least 4 characters.

Notes

After the screen lock is enabled, every time you boot up the screen, system will request the passkey.

If you forgot your passkey, please contact your administrator to reset your passkey.

4.2 Home

Once logged into the system, the user will be taken to the **Home** page as shown in the following figure.

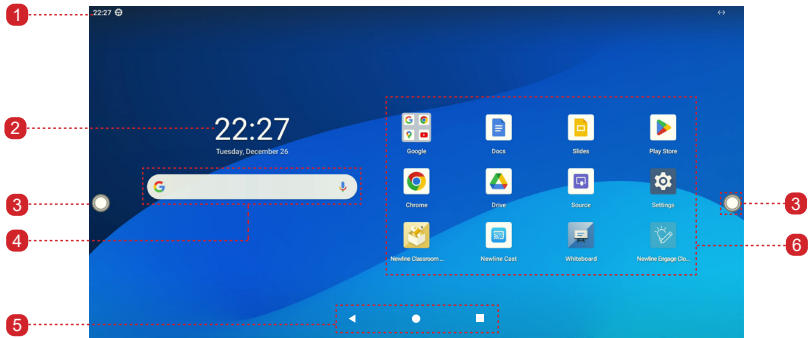



- 1 Status Bar
- 2 Clock & Date and Week
- 3 Toolbar
- 4 Google Search Bar
- 5 Home button
- 6 Application

- **Gestures**

Gesture	Functions
Slide Up	Slide up to view all the applications.
Slide Down	Slide down to expand the quick setting menu.
Slide Right	Slide right to enter the google login interface.

- **Home button**

Icon	Functions
	Return to the previous menu or exit an app.
	Back to the home page.
	Enter the task management.

- **Notes**







You can enter **Settings> System > Gestures> System navigation** to set the button.



- **Toolbar**

OPS, Home, Annotation Mode, Whiteboard, Quick access bar, Dashboard, Task manager and Return icons are displayed by default in the toolbar on both sides of the screen.

You may hide toolbar in the Settings or move it on the screen, shrink or expand by using touch gestures.

The functions of the toolbar are as follows:

Icon	Functions
	Tap to switch to the OPS source, long press to customize the icon.
	Go to Home page.
	Tap once to start annotation mode, tap again to stop annotation and take a screenshot.
	Switch to whiteboard mode.
	Minimize or maximize the toolbar.
	Tap to enter the quick access bar.

Icon	Functions
	Tap to enter the Dashboard.
	App switcher allows the user to manage currently running applications. Swipe left or right to view currently running applications, swipe up or down to close the application or tap "clear all" to close all the applications.
	Return to the previous menu or exit an app.

Shrink and Expand:

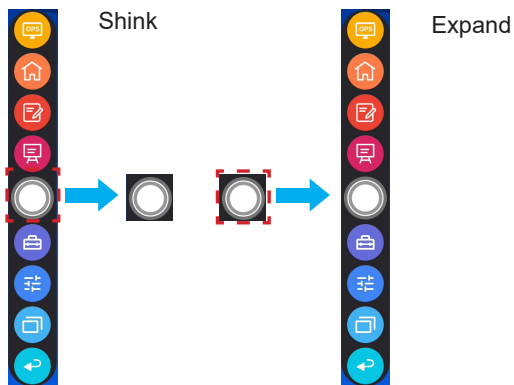

Quick Access Bar

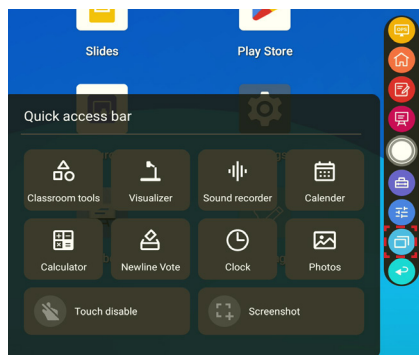

Dashboard:

Menu	Functions
Sound	1 Option includes standard, meeting, classroom, custom mode, standard mode is default; 2 After selecting customization, the interface displays bass, treble and balance, and the default values are 0, 0 and 50.
Image	1 Includes standard, bright, soft, custom four options, standard mode is default; 2 Click Customize to display the image Settings, including brightness, contrast, color, saturation and sharpness Settings. The default values are all 50.

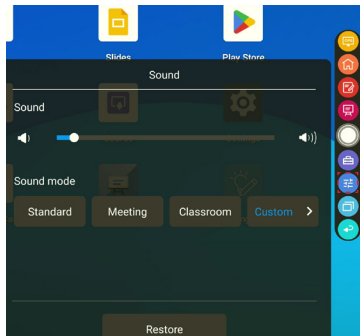

Toolbar > Floating bar

Press the toolbar and drag it out, the sidebar can be transformed into a floating bar.

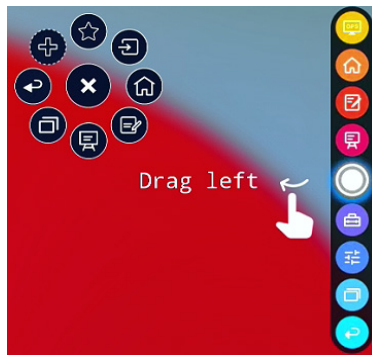

Compass floating bar > Toolbar

Drag the floating bar to the edge of the screen, the Compass floating bar can be back to the toolbar.

In the floating bar, users can tap the icon to enter function interface, add and delete icons, add custom icons, drag the tool bar with their fingers to move around on the screen.

Standard > Minimized

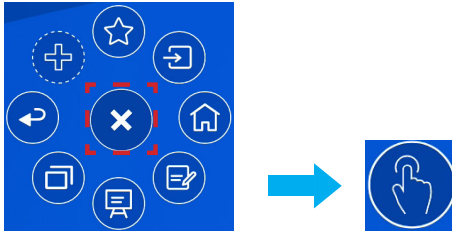

Standard > Favorite

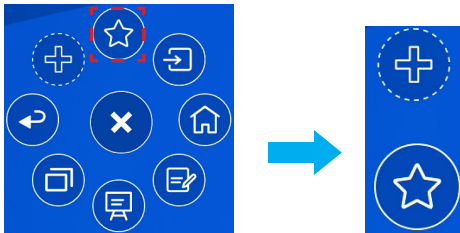

Delete icons

Long press the icons to enter the icon deleting status, tap the × icon on the upper left corner to delete icons.

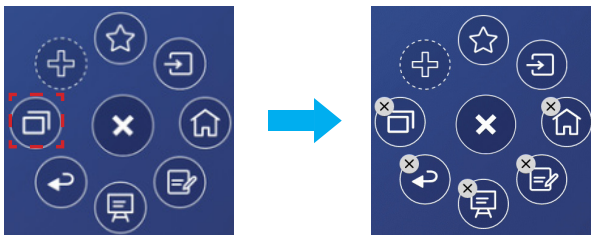

Signal source

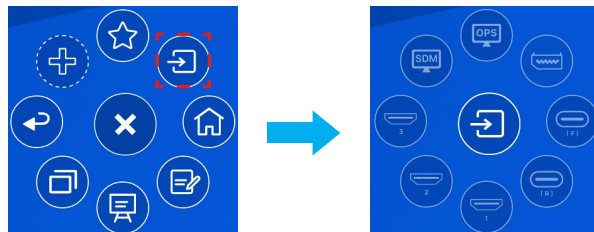

4.3 Whiteboard

The whiteboard function is designed to present conference writing to attendees in a quick and easy manner. The whiteboard has the following functions:

- **Discussion and screen annotation**

On the whiteboard page, you can select pen type, width, and color to write or annotate on the screen. You can also erase selected content or clear all content on the screen.

- **Page navigation**

Preview or delete pages.

- **Palm rejection**

When Palm rejection is turned on, fingers and pen can write and draw, but palm and fist would not be recognized.

- **Palm eraser**

When Palm eraser is turned on, fingers and pens can also be recognized, and palm and fist will be recognized as large eraser.



Note

The Palm Rejection and Palm eraser function are available for whiteboard and annotation application, both of which are mutually exclusive and cannot be turned off simultaneously. You can turn on/off Palm Rejection function on the whiteboard setting page.

- **Whiteboard Mode**

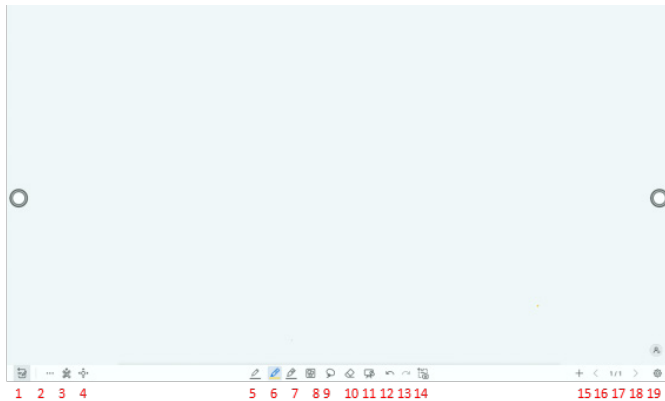
- Tap **whiteboard** icon on the Home page or tap  on either side toolbar to enter the embedded whiteboard mode, as shown in the following figure:



- Tap  on the side toolbar or tap  in discussion mode to enter annotation mode. In annotation mode, a transparent layer lays over the screen, letting you write over whatever is on the screen until you exit annotation mode.

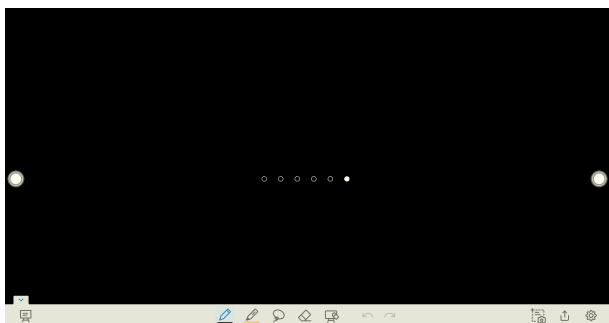

20

21 22 23

SN	Icon Name	Icon Function
1	Mode Switch	Tap to switch to annotation mode.
2	More	Tap to enter options interface. Users can insert image, Text, Sticky note, Search Image or Search Web etc.
3	QR Code	Tap to export the whiteboard data into QR Code.
4	Move Canvas	Tap to enter move canvas function, press and move your finger in the page to move canvas and content on it.
5	Pen	Tap to use the pen function, and the icon turns into blue. Tap and hold the icon for two seconds to set the size and color.
6	Highlighter	Tap to use the highlighter function, and the icon will turn blue. Tap and hold the icon for two seconds to set the highlighter size or color.
7	AI Pen	Tap to use the AI pen function, tap and hold the icon for two seconds to select the pen type or set the size and color.
8	Insert Auto shape	Tap to enter the auto shape selection interface. Users can insert the shapes and set the shapes color.
9	Select	Tap to select and edit the whiteboard content. When the object is selected, users can move, zoom in/out, copy, cut, rotate, lock, change layer or delete object.
10	Eraser	Tap to select the eraser function and the icon will turn blue. Tap and hold the icon for two seconds to set the way of eraser.
11	Clear	Clear all data on this page.
12	Undo	Back to the previous step.

SN	Icon Name	Icon Function
13	Redo	Tap to restore the action that was cancelled in the previous step.
14	Capture	Tap to take a screenshot.
15	New Page	Tap to add a new page.
16	Previous Page	Tap to back to the previous page.
17	Next Page	Tap to go to the next page.
18	Navigation	Tap to show the page thumbnails.
19	Settings	Tap to enter the whiteboard setting interface.
20	Mode Switch	Tap to switch to discussion mode.
21	Save	Tap to enter saving screenshot interface.
22	Screenshot	Tap to take a screenshot, and save the data to Photos and Files>images>image .
23	Settings	Tap to enter the annotation setting interface.

4.3.1 Whiteboard Functions

- **New Page and Settings**

- Create a new page

In discussion mode, tap **+** to create a new page. Up to 99 pages can be created. See the following figure:

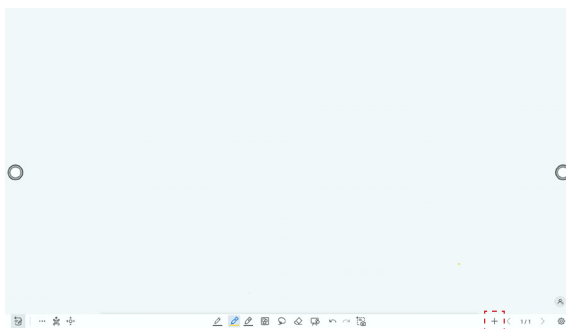

- Page settings

Tap and hold **+** for two seconds to enter the background setting. Select the color and pattern and click **ADD** to add a new page. The set color and pattern will be displayed on the new page, as shown in the following figure.

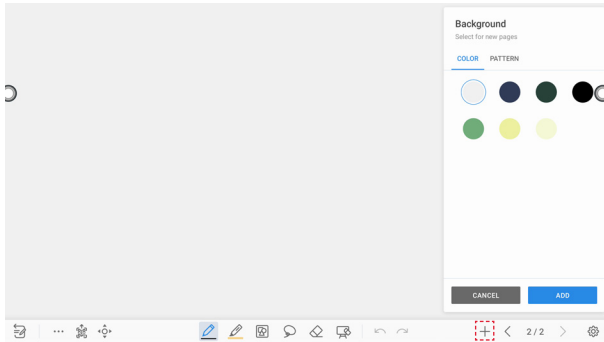

• Mode Switch

Tap  in the lower left corner of the whiteboard mode to switch to annotation modes.

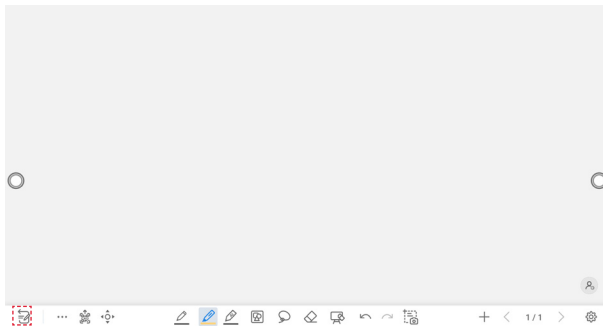

• Options

Tap the  icon to enter options interface. Users can manage files, add Text, Sticky note, Search Image or Search Web etc.

On the **FILE** items, you can import data from file management, save whiteboard files and export the whiteboard page.

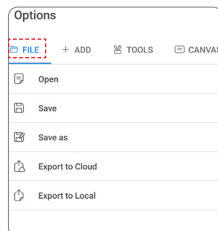

On the **ADD** items, you can import the pictures, Text, Smart table, Sticky note, PDF document, Concept map, video, and audio from system files and USB device. You also can import the Search Image, Search Web and YouTube on the internet.

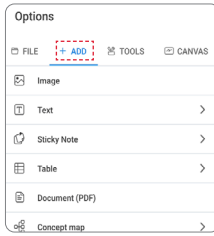

On the **TOOLS** items, you can use rulers to draw line or shape on the page, import the visualizer image etc.

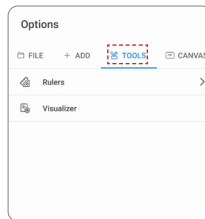

On the **CANVAS** items, you can choose split mode to set the split application.

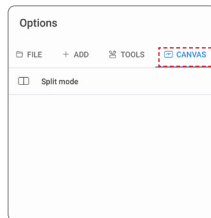

• QR code export

On the Whiteboard, tap  pop up QR code exporting windows. You can export the whiteboard page into QR Code, before that, you can customize the number of export page, change the export format at first.

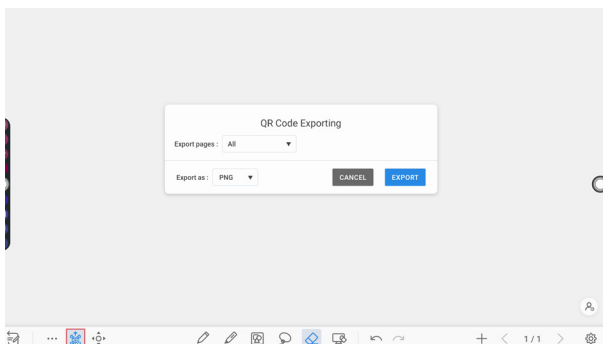





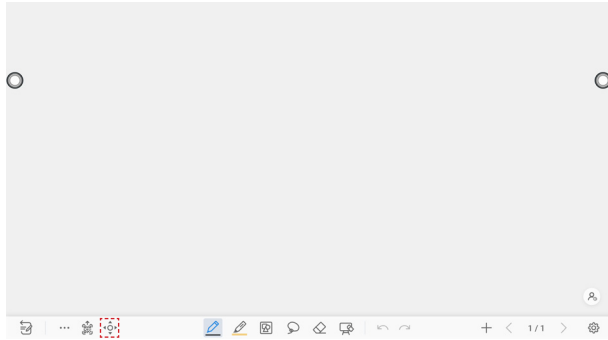

• Move canvas

On the whiteboard, tap the icon to enter move canvas function, press and move your finger in the page to move canvas and content on it.





• Pen Type

On the Whiteboard, four types of pens are supported: hard pen, brush, highlighter and AI pen.

- Pen  and  : used to write.
- Highlighter  : used to highlight. Characters covered by comments are still visible.
- AI Pen  ,  and  : used to write, support text recognition, shape recognition and formula recognition.

• Line Size and Color

On the Whiteboard, tap and hold  or  for two seconds to set the size and color. You can select the line size and color for writing, as shown in the following figure:

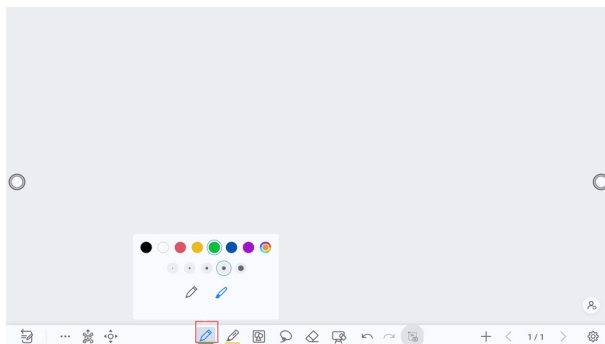

• Insert auto shape

On the Whiteboard, tap  to insert the shape and three-dimensional diagram or set the shapes and color.

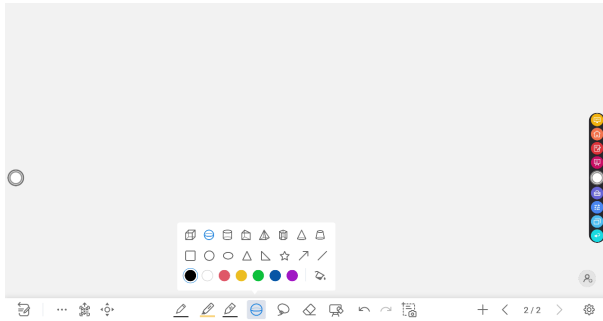

The  icon supports three status:

- Unavailable: The icon is unavailable when users insert arrow and line;
- Unselected: The edge of shapes are colored when the icon is not selected;
- Selected: the shape will be filled with colors when you import the shape.

• Select

On the Whiteboard, tap  and user could choose the data on the page to move/ zoom in/ zoom out/ rotate/change colors.

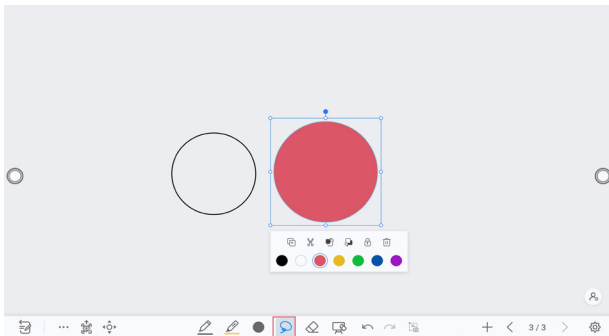



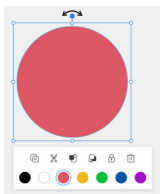



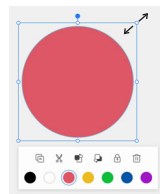

Rotate:





Zoom in/out:



Icon	Functions
	Long press this icon to rotate the selected items.
	Tap this icon to copy the items.
	Tap this icon to cut the items.
	Tap this icon to push to top layer.
	Tap this icon to push to bottom layer.
	Tap this icon to lock the layer.
	Tap this icon to delete the items.
	Paste (Long press the screen around two seconds. The icon will appear only after one object copied or cut)
	Tap this icon to unlock the layer. (The icon will appear only after one object locked)

• Eraser

Two methods are available to erase written errors or content as follows:

- Partial eraser: Tap  to clear the passing part of eraser.
- Object eraser: Tap  to clear the whole object.

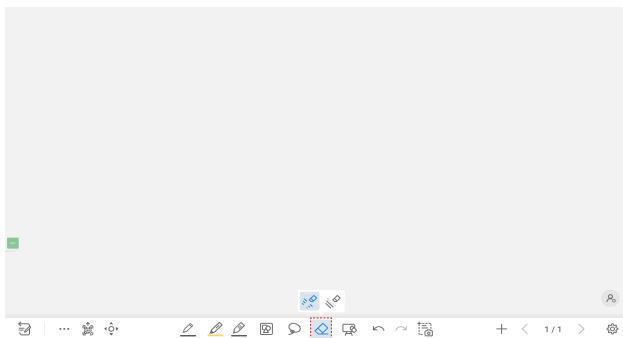

Note

You can tap  to enter **Settings> Default settings>Eraser** to set the type of eraser.

• Clear All

On the Whiteboard page, tap  to show the pop-up windows to clear all content on the current page, as shown in the following figure:

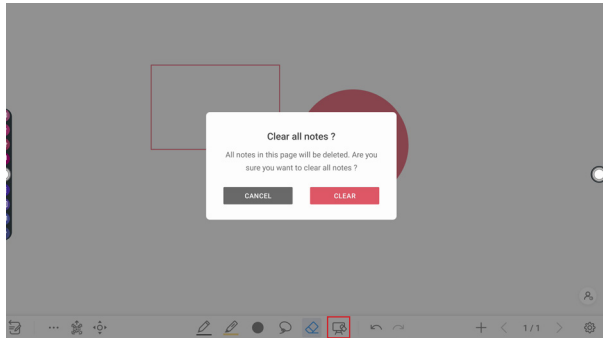

• Capture

Tap  to take a screenshot and save the data to **Photos** and **Files>images>image**.

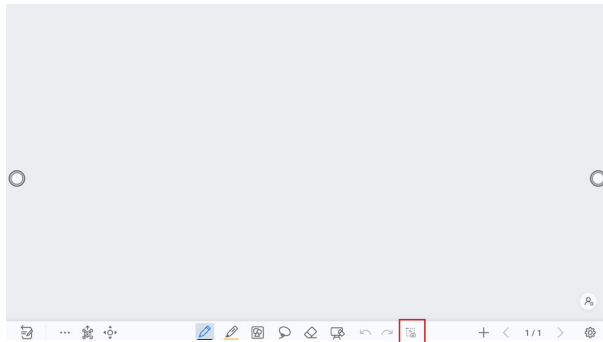

4.3.2 Whiteboard Setting

Tap the  icon to enter the settings bar, users can set the object recognition, action hint, default settings and handwriting recognition.

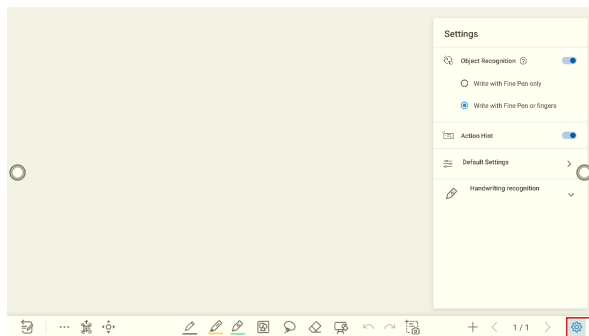

• Object recognition

Users can drag the slider to enable the object detection function, tap ⓘ icon to view details functions, as shown in the following figure:

Example 1: Turn on write with Fine Pen only

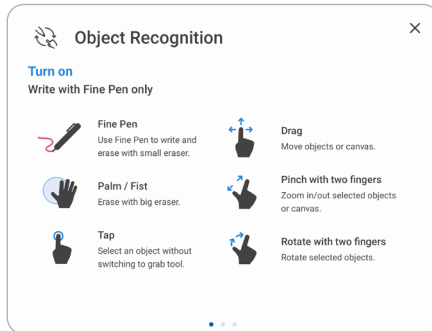

- Fine Pen (2mm): User Fine Pen to write and erase with small eraser.
- Fist/palm: Identified as an eraser (100 pt).
- Tap: Select an object without switching to grab tool.
- Drag: Move objects or canvas.
- Pinch with two fingers: Zoom in/out selected objects or canvas.
- Rotate with two fingers: Rotate selected objects.

Example 2: Turn on write with Fine Pen or fingers

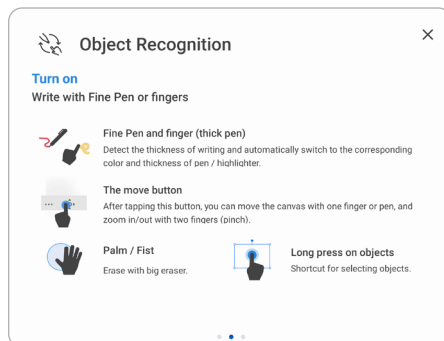

- Fine Pen and finger (thick pen): User Fine Pen or finger (thick pen) to write. System will detect the thickness of writing and automatically switch to the corresponding color and thickness of pen/highlighter.
- The move button: After tapping this button, you can move the canvas with one finger or pen, and zoom in/out with two fingers (pinch).
- Palm/Fist: Erase with big eraser.
- Long press on objects: Shortcut for selecting objects.

Example 3: Turn off object recognition

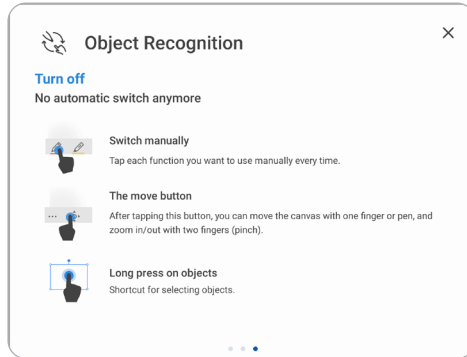

- Switch manually: Tap each function you want to use manually every time.
- The move button: After tapping this button, you can move the canvas with one finger or pen, and zoom in/out with two fingers (pinch).
- Long press on objects: shortcut for selecting objects.

Palm Rejection: Drag the slider to enable and disable the Palm Rejection. When Palm rejection is turned on, fingers and pen can write and draw, but palm and fist would not be recognized.

Action hint: Drag the slider to enable the action hint.

Default settings: Tap the button to enter the default setting page, any new page will use the default settings. Users can set whiteboard page background, change the color and thickness of Smooth Pen and Highlighter, change the default type of eraser, both object eraser and partial eraser can be set.

Handwriting recognition: Tap to select the language of recognition.

4.3.3 Page Operations

You can preview, select, and delete the writing page, you also can save the page to the USB Flash device or local files.

• Page Preview

Tap **1 / 1** at the lower right corner in the whiteboard mode. All pages will be displayed. Tap one page to switch to that page for more operations, as shown in the following figure.

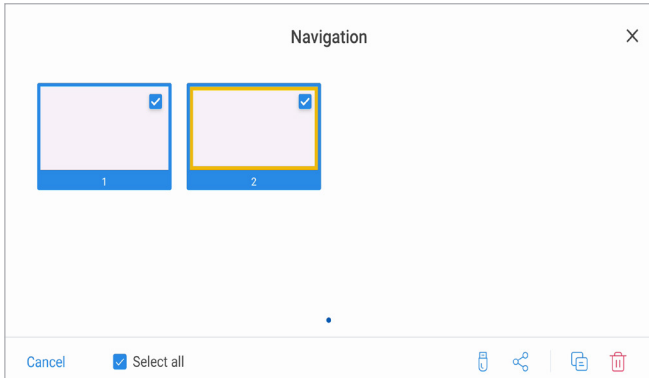





Note

Only 8 pages are displayed at once. You can slide right or left using one finger to see more.

• Page Operation

On the **Navigation** page, you can select or delete writing pages according to requirements, as shown in the following figure:

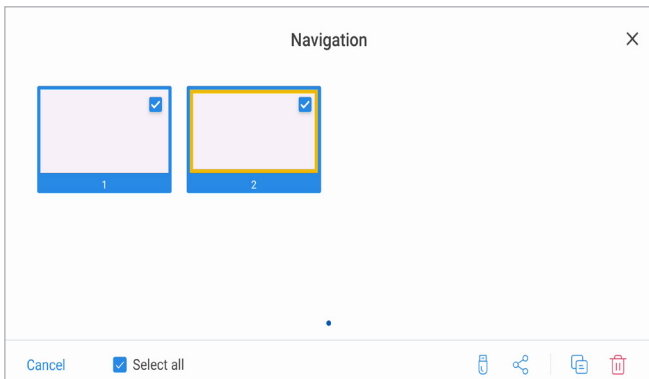

- Tap  to select all pages.
- Tap  to save the writing pages to USB flash device.
- Tap  to share the writing pages to local file or AquaMail.
- Tap  to copy the page.
- Tap  to delete selected pages.



4.3.4 Annotation



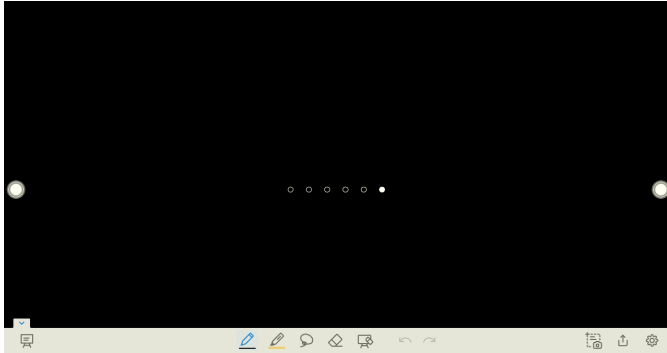

In annotation mode, the system generates a transparent layer at the top of the screen, and users can add annotations to the transparent layer until the annotation mode is exited.

The user can enter the annotation mode through the following two methods:

- Tap the “” icon in the sidebar;
- In the “Whiteboard” interface, tap the “” icon.





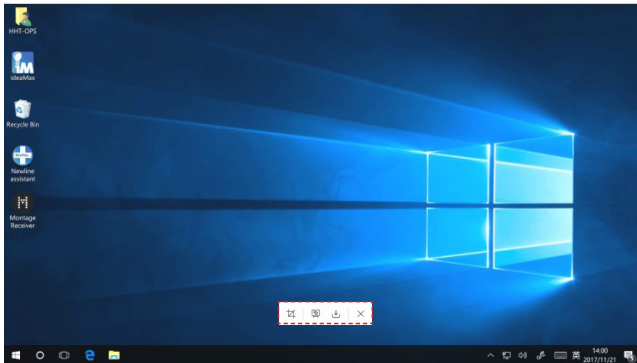

- **Take a Screenshot**

Tap  icon to enter take a screenshot interface, users can tap  icon to take a screenshot; tap  icon to switch to whiteboard mode; tap  icon to save screenshot, tap  icon to exit screenshot.



• Save screenshot

Tap  icon to pop up save screenshot interface, you can save or share screenshot as following:

- Tap  to select all pages.
- Tap  to view tips.
- Tap  to save the annotation pages to USB flash device.
- Tap  to share the annotation pages to local file or AquaMail.

Note

You can enter **Files > images > image** folder to view or get screenshots.

• Settings

Tap  icon to pop up settings interface, you can turn on/off object recognition, Action hint and Auto screenshot. If auto screenshot setting is on, system will automatic take a screenshot when exiting the annotation mode.

Note

If you need more details instruction, please refer to whiteboard setting.

4.4 Application

On the Home page, slide up to view all applications. The following figure shows applications that the system is delivered with.

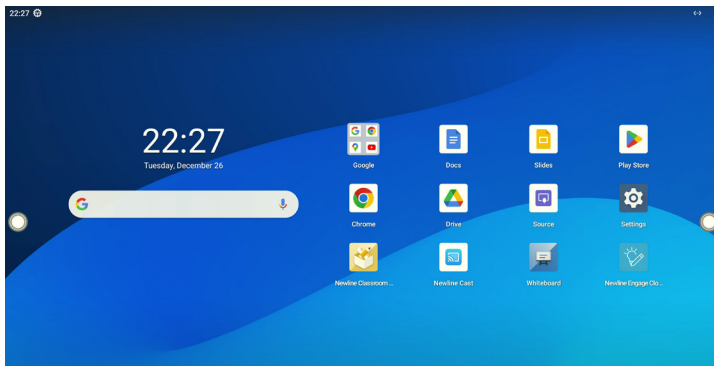

4.4.1 Google App Store

Enter the Google App Store, you can install apps as you need, enter my apps to uninstall the applications.

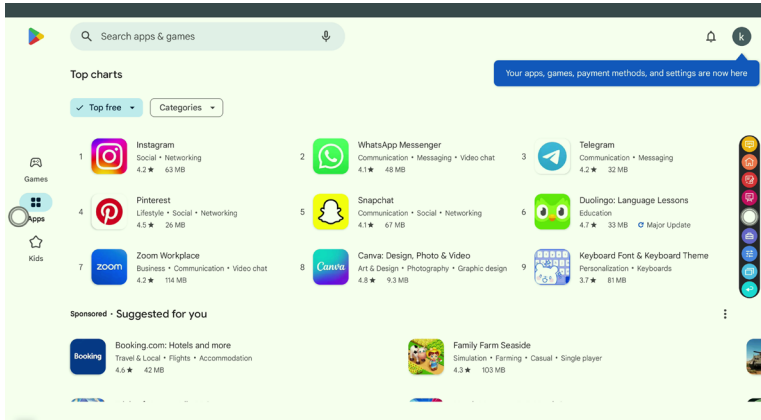

Note

Before installing an application, ensure that the installation lock is closed.

4.4.2 Newline display management+

Newline Display Management Plus is a remote display management solution that enables users to centrally manage the Newline displays from the comfort of their desk. Users can deploy and install apps, configure display settings, and push updates without communicating back and forth.

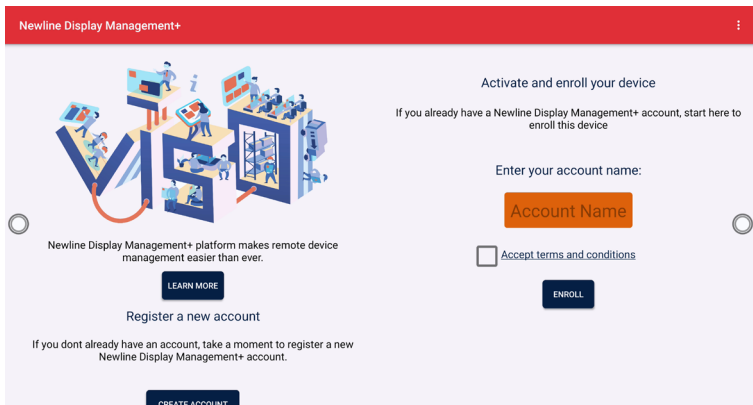

Note

Please visit our website at www.newline-interactive.com and enter **Product > software solutions** to get more details about Newline Cast and Newline Display Management.

4.4.3 Newline Cast+

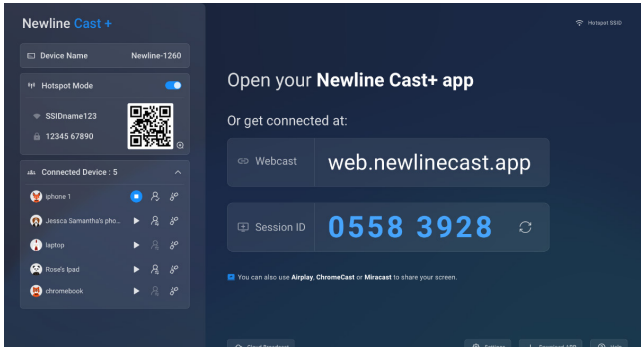

Effortless Screen Sharing: Share your smartphone or laptop screen with a single tap. We offer Non-app casting via Airplay/Chrome Cast/Miracast/DLNA/Webcast, also supporting mobile and PC apps among iOS/Mac OS/Windows/Android, eliminating the need for cables or adapters.

Tap  on the Home Page to enter Newline Cast+. On screen directions will appear for you to follow in order to wirelessly cast to the display, as shown in the following figure:



4.4.4 Files

The product supports connection to USB flash memory. In Files application, you can preview all files in the internal storage and storage devices connected via USB ports.

Functions	Instruction
File Preview	Tap the submenu on the left side to preview recent files, images, videos, audio, documents and downloads files, files on the external storage devices connected via the USB ports.
File Search	Tap  and enter the keywords in the search box. The system will display a list of files that match the searched for keywords.
File Filtering	Tap  on the upper right corner to choose the file sorted by name or modified.
File Operation	Tap  on the upper right corner to select, copy, paste, delete, move and share the files.

4.4.5 Visualizer

This product supports the use of external visualizer, after the visualizer is connected, tap the “” icon to access the visualizer application.



SN	Icon Name	Icon Function
1	Annotation	Tap to enter annotation mode.
2	Whiteboard	Tap to enter whiteboard mode.
3	Screen Display	Tap to display the visualizer camera.
4	Screen Split Mode (2)	Tap to display in 2 split screen mode.
5	Screen Split Mode (4)	Tap to display in 4 split screen mode.
6	Camera Switch	Tap to switched the camera on back and forth.
7	Capture	Tap to take a screenshot, you can paste the screenshot on whiteboard, save it to files, save it to USB or Share it.
8	Rotation (Clockwise direction)	Rotate the camera image by clockwise direction.
9	Rotation (Counter-Clockwise direction)	Rotate the camera image by counter-clockwise direction.
10	Adjustment	Tap to adjust the brightness, contrast, saturation, sharpness.
11	Setting	Tap to set image mode, resolution, color system.
12	Exit	Tap to exit the visualizer.
13	Insert	Tap to capture or inset image from the files.

4.4.6 Vote

Tap the “” icon on the Application program to enter “**Vote**”:

Users can input a topic (not required) and input options (2 options minimum, 10 options maximum). After tapping “**Complete**”, a QR code is generated for users to scan with their mobile devices.

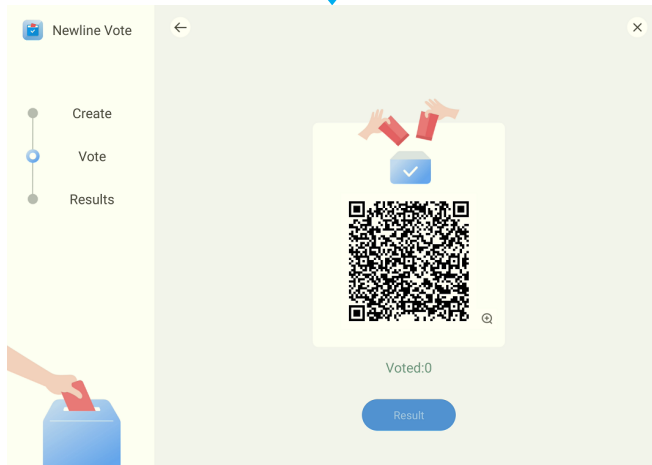
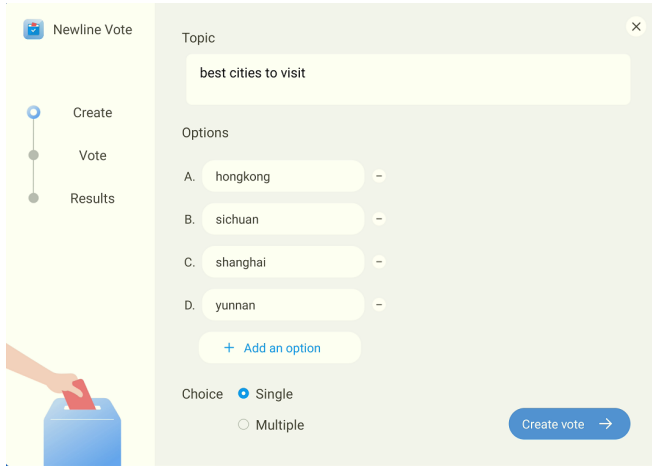

Note

“Vote” only works when both the panel and the mobile device are connected to the internet.

User will see the voting topic and options on the mobile device after the QR code is scanned. After making the selection, tap “submit” to cast vote.

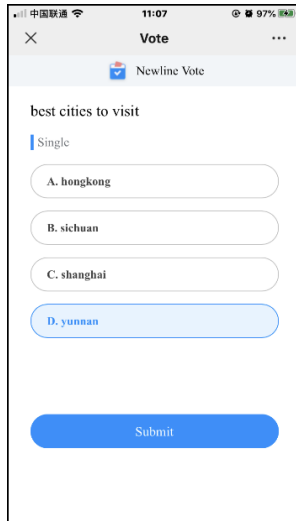

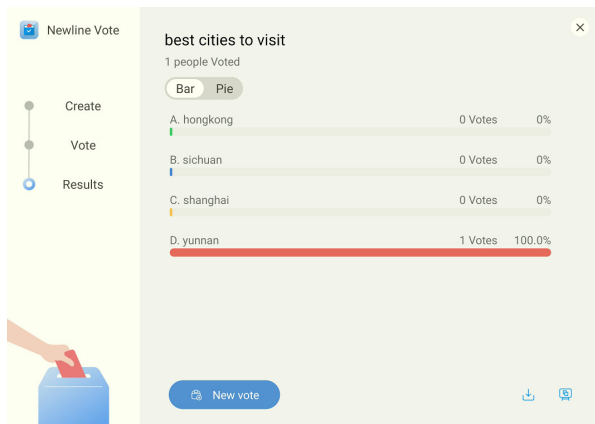

In the voting process, the number of voters is displayed in real-time under the QR code. Users can tap “**Result**” button to terminate the current vote process and show the voting results. The voting results can be displayed in the “**Pie chart**” or “**Bar chart**” form.

Users can tap **Insert into whiteboard** to insert the current voting results into the whiteboard.



4.5 Extended Functions

Functions	Status	Operation
Sound Only	After entering the sound only mode, the screen was extinguished and the sound played normally.	Turn on Tap the icon  in the quick setting menu. Turn off Tap anywhere on the screen.
Child lock	When the function is turned on, the child lock icon will appear in the upper right corner of the screen, and the front button, touch and remote control functions will all fail.	Turn on Long press the  button on the front button for 5 seconds. Turn off Long press the  button on the front button to exit the lock.
Sleep	Enter the sleep state, the screen and backlight are off, the Android system and OPS are running normally	Turn on Press the power button Turn off 1 Press the power button to wake up 2 Touch wake-up 3 Access source wake-up
Freeze	After entering the freeze screen mode, the freeze screen icon appears in the upper right corner of the screen	Turn on 1 Press the freeze button on the remote control; 2 Tap the freeze icon in the Quick Settings menu. Turn off 1 Double-click the screen; 2 Press the freeze button on the remote control.
Drop screen	The screen height was reduced by a third	Turn on Four fingers slide down Turn off 1 Tap the top area to back to the original page; 2 Switch the signal source to exit the drop screen.

4.5.1 Capture

Using the screenshot function, you can capture the current page and save it in the form of a picture. You can enter the screenshot by the following way:

- Press the capture icon on the remote control;
- Tap the screenshot icon on the Quick access bar;
- Tap the save icon on the annotation page.

Common functions

- Freedom: Select the free mode, you can freely drag the screenshot box to adjust the screenshot screen;
- Full screen: Select full screen mode, full screen capture;
- Save: Click Save to get the screenshot and save it automatically;
- Insert: Take the screen capture as a picture and insert it into the whiteboard;
- Close: Exit screenshot mode.

Save screenshot



- Save to pictures: save the screenshot to pictures.
- Print: enter the print interface to print the screenshot.
- Bluetooth: share the screenshot by Bluetooth.
- Nearby share: share the screenshot by nearby share.
- Aqua mail: save the screenshot to Aqua mail.

4.5.2 Sources

On the Home page, tap  to enter the signal source selection, including OPS / Display Port / HDMI 1 / HDMI 2 / HDMI 3 / (F)Type C / (R) TYPE C /SDM.

The icon without signal source connected is gray, and the icon with signal source connected is white. After you choose white icon, the content of the signal source can be displayed in the preview window for real-time preview.









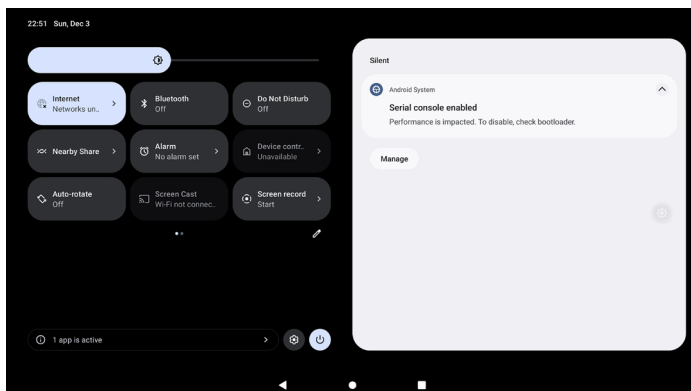





You can enter sources interface by the following methods:

- Tap the  icon on the Home page;
- Tap the  icon on the remote control.

4.5.3 Quick Setting Menu

Using fingers and swipe down from the top of the screen to access the Quick Settings menu, shortcuts are displayed on the left and notifications are displayed on the right, as shown in the following figure.



Icon	Functions
	Drag the slider to adjust the brightness.
	Tap to enter the setting of internet.
	Tap to enable or disable the Bluetooth.
	Tap to enable or disable the Do Not Disturb function.
	Tap to enter the Nearby Share interface.
	Tap to enter the setting of Alarm.
	Tap to enable or disable the Device Control function.
	Tap to enable or disable the Auto-Rotate function.
	Tap to access the Screen Cast application.
	Tap to access the Screen Record application.
	Tap to edit the shortcut menu, hold and drag to add the items.
	Tap to enter the account selection interface, you can switch users, add user and guest.
	Tap to enter the settings page.
	Tap to select access to lockdown, power off and restart.



4.5.4 Automatically Power Off

If the screen is left un-operated for a specified duration, it will automatically turn off. Choose **Settings**> **Power** to set the duration. For details on the setting method, see "Power Setting".

If it is operated again within specified duration, the screen is unlocked. Otherwise, the screen enters the power off mode.

4.6 Settings

Enter the system setting page using one of the following methods:

- Tap  on the **Home** page.
- In the **Quick Setting Menu**, tap the  icon.
- Press **MENU** button on the remote control.

4.6.1 Network & Internet

Enter the **Network&Internet** submenu to enable Wi-Fi or Ethernet, view network information, and enable the Wake on LAN function.

Menu	Setting	Functions
Internet	Ethernet	When the RJ45 port is properly connected to the network cable, tap the button to View the MAC address, IP address, gateway, subnet mask, and DNS information.
	Wi-Fi	Default is on, when both Ethernet and Wi-Fi are available, Ethernet is preferred.
	Network Preferences	Enable or disable the Wi-Fi automatically turn on, install the certificates as you need.
Wake on LAN	ON/OFF	Tap the button to enable Wake on LAN function. Default is off, connecting the wired network can wake up the display.
Wake on Wireless LAN	ON/OFF	Tap the button to enable Wake on wireless LAN function. Default is off, connecting the wireless network can wake up the display.
IP Control	ON/OFF	IP Control uses the internet and Internet Protocol to transmit data and enable devices to communicate wirelessly.
Hotspot & tethering	Wi-Fi hotspot	Share a network through a Wi-Fi hotspot
	USB tethering	Share the network via USB
	Bluetooth tethering	Share the network via Bluetooth
Date Saver	ON/OFF	Enable the function to help reduce the data usage.
VPN	VPN	Configure the VPN and verify the CA certificate
Private DNS	ON/OFF	Tap to select DNS mode, off, automatic, private DNS provider hostname three modes are available

4.6.2 Connected devices

Enter the **Connected devices** submenu to check the connected devices, system will automatically detect and connect to new device via Bluetooth.

Menu	Functions
USB	After the device is connected via USB, it can transfer files or charge.
Pairing new device	Turn on Bluetooth and automatically search for available devices nearby. 1 Pairing other display, mobile phones, computers, need to enter the pairing password or two-way confirmation; 2 Bluetooth audio, keyboard and mouse can be directly paired, no need to enter a password.
See all	All devices can be viewed, including paired and available devices.
Connection preference	It can be set to print/screen/share nearby through Bluetooth.

4.6.3 Apps

Enter the **Apps** submenu to view downloaded applications, screen time, unused apps and Special app access.

Menu	Functions
All apps	Display the installed app, you can enter a single app to set application information, such as: open notification, view memory and mobile data and other information.
Default apps	Display default apps
Screen time	Display the usage time of each app
Unused apps	Display unused apps
Special app access	App access

4.6.4 Notifications

Enter the **Notifications** submenu to manage the notifications about apps, view the notification history, set the notifications about conversations and etc.

Menu	Functions
App settings	Sets whether app notifications are turned on.
Notification history	Display notification history
Device & app notifications	Set which apps or devices can read notifications.
Notifications lock screen	Set how to display notifications on the lock screen page.

Menu	Functions
Do not disturb	Set how apps and notifications are displayed in Do not Disturb mode.
Wireless emergency alerts	Switch ON/OFF
Hide silent notifications in status bar	Switch ON/OFF
Allow notification snoozing	Switch ON/OFF
Notification dot on app icon	Switch ON/OFF
Enhanced notifications	Switch ON/OFF

4.6.5 Storage

Enter the **Storage** submenu to view the storage and space distribution of the device and disk.

Menu	Functions
This device	Displays the memory for the display
USB	Displays the memory of the external USB
SD card	Displays the memory of the SD card

4.6.6 Sound and vibration

Enter the **Sounds and vibration** submenu to adjust the sound of media volume, call volume, alarm volume and notification volume.

Default notification sound, Default alarm sound, Screen lock sound and Touch sounds also can be set on the interface.

Menu	Functions
Media volume	Adjust the volume of media
Call volume	Adjust the volume of call
Alarm volume	Adjust the volume of alarm
Notification volume	Adjust the volume of Notification

Menu	Functions
Sound output selections	Speaker: Select this option, sound will come out of the IFPD speaker. S/PDIF: Select this option, sound will come out of the device connected to S/PDIF port. ARC: Select this option, sound will come out of the device connected to HDMI out(ARC) port. Lineout: Select this option, sound will come out of the device connected to Line out port. Mixes: Select this option, sound will be output from all four of these options simultaneously.
Do not disturb	Turn Do not Disturb mode on or off, set the apps available in Do not disturb mode.
Media	Set the media information.
Default Notification sound	Set the default Notification sound.
Default alarm sound	Set the default alarm sound.
Screen lock sound	Switch ON/OFF.
Touch sounds	Switch ON/OFF.

4.6.7 Display

Enter the **Display** submenu to set the Brightness, Lock screen, Screen timeout, Dark theme, Display size and text, Theme, logo, Set logo, Colours, Screen saver.

Menu	Setting	Functions
Brightness	Brightness level	Adjust brightness level
	Adaptive brightness	Switch on/off, After opening, the screen is adjusted to the eye protection state according to the light perception.
Lock display	Lock screen	Set the operation information of the lock screen page.
	Screen timeout	Set the screen saver time, the screen will lock automatically after reaching the set time.
Appearance	Dark theme	Switch on/off, default off.
	Display text and size	Set font size and screen size.
Theme	Google theme	Switch on/off.
	Newline theme 1	Switch on/off, same theme as newline Q.
	Newline theme 2	Switch on/off, same theme as newline Z.

Menu	Setting	Functions
Logo		Switch ON/OFF
Color		Switch ON/OFF
Screen saver		Switch ON/OFF

4.6.8 Wallpaper & Style

Enter the **Wallpaper & Style** submenu to customize the wallpaper from file viewer and photos.

Menu	Functions
Change wallpaper	Changeable wallpaper (wallpaper needs to be less than 10M and resolution is less than or equal to 4K)
Wallpaper Color	Changeable wallpaper color
Basic colors	Changeable Basic colors
Dark theme	Switch ON/OFF
Themed icons	Switch ON/OFF

4.6.9 Security

Enter the **Security** submenu to view the security status, find my device, update the security and add the screen lock.

Menu	Functions
Google Play protect	Check the apps and device for harmful behavior.
Find my device	Log into your google account and follow the prompts to find your missing device.
Security update	Check for update
Screen lock	None: Turn off the screen lock.
	Swipe: Swipe the screen to unlock.
	Pattern: Draw an unlock pattern, the pattern need connect at least 4 dots.
	PIN: Set the pin code, the pin must be at least 4 digits.
	Password: Set the password, the password must be at least 4 characters.
More security settings	Set the smart lock, view and install the encryption and credentials.

4.6.10 Location

Enter the **Location** submenu to use location, view the apps recently accessed location and location services.

Menu	Functions
Use location	Switch ON/OFF
App location permissions	Set the permission of app to access the device's location

4.6.11 Passwords & Account

Enter the passwords and accounts submenu to view and add accounts and passwords.

Menu	Functions
Passwords	Tap to logon to the google account
Autofill service	Switch ON/OFF
Accounts	Add a new google account
Automatically sync app data	Switch ON/OFF

4.6.12 Tool Bar

Enter the **Tool Bar** submenu to set whether to display the tool bar.

- Left: Tap to turn on/off the left tool bar.
- Right: Tap to turn on/off the right tool bar.

4.6.13 Input and Output Setting

Enter the **Input and Output** submenu to set the Home source and USB connection, enable new input source and CEC auto.

Menu	Functions
Starting Source	Customize settings to connect to the signal source after power on.
New Input Source	Switch ON/OFF After the function is enabled, the system can automatically switch to the screen of the newly connected signal source. The priorities are as follows: Starting Source →New input source →CEC
CEC Auto Power On	“ CEC Auto Power On ” is enabled, when the HDMI port of the panel is connected to a CEC device (such as a DVD), and both the CEC device and the panel are turned off, if the CEC device is turned on, the panel automatically turns on after receiving command from the CEC. Allows connected devices to turn on the power of the display. Default is on, automatically follow the multi-user Settings.

Menu	Functions
CEC Auto Power Off	Allows the display to turn off the power of the connected devices. "CEC Auto Power Off" is enabled, when the HDMI port of the panel is connected to a CEC device, and both the CEC device and the panel are turned on, if the panel is turned off, the CEC device automatically turns off after receiving the command; if the CEC device is turned off, the panel automatically turns off after receiving the command.
App auto-launch	Tap to select the app or a URL automatically running on startup, the app auto-launch only acts on Android system. 1. Default is off; 2. Only one Newline app can be selected at a time; 3. Enter the link, boot automatically jump to the URL.

4.6.14 Power Setting

Enter the **Power** submenu to set power on or power off as following:

Menu	Setting	Functions
Auto Power On	Switch ON/OFF	Tap to enable the function, users can set the power on time.
Power On Time	Set the time	Set the power on time, system will automatic power on at the customize time.
Auto Power Off	Switch ON/OFF	Tap to enable the function, users can set the power off time.
Power Off Time	Set the time	Set the power off time, system will automatic power off at the customize time.
Energy Saving	Set the frequency to shut down automatically	Set a duration after which the screen enters the lock mode if the screen is left un-operated. After the screen is locked, if the user does not operate the screen within 120s, the screen enters the power off mode. The duration can be set to 30 MIN, 60 MIN, 90 MIN, 120MIN or NEVER . You can also customize this duration and the range is 3 minutes to 480 minutes.
Power Button Option	Sleep	Set the system enter sleep mode when users press power button.
	Power off	Set the system enter power off when users press power button.
Tap to wake screen	Switch ON/OFF	Tap to enable the function, users can touch the screen to wake up the system from sleep mode.
Signal Source Wake-up	Switch ON/OFF	Tap to enable the function, access signal source can wake up the display.

Note

NEVER indicates that the automatic power off mode function is not enabled.

4.6.15 Screen Eye Filters

Enter the **Screen Eye Filters** submenu to set **Writing Mode Filter**, **Brightness Mode Filter** and **Bluelight filter**. If only the **Bluelight filter** setting is on, the **Filter level** can be set.

Menu	Setting	Functions
Writing Mode Filters	Switch ON/OFF	Tap to enable the function, the display will change whiteboard brightness under writing mode, Writing Mode Filters and Brightness Mode Filter are mutually exclusive and cannot be opened at the same time.
Brightness Mode Filter	Switch ON/OFF	Tap to enable the function, the display will change screen brightness based on ambient light,
Bluelight Filter	Switch ON/OFF	Tap to enable the function, the filter level tints your screen amber, this makes it easier to look at your screen or read in light.
Filter level	Set the filter level	Set the filter amplitude

Note

Studies have shown that just as the ultra-violet rays can cause eye damage, the shortwave-length blue light rays from displays can cause eyestrain, retina damage, and affect vision over time. Newline Blue Light filter is an eye protection feature that can reduce the blue light. TT-6523QA /TT-7523QA /TT-8623QA has obtained this certification.

For protecting your eyes against prolonged display use, we highly recommend you to do the following:

- Let your eyes rest for 10 minutes after 2 hours of continues use.
- Roll your eyes upward towards your eyebrows, and then roll your eyes in a large circle every few hours.
- For every 20 minutes of display viewing, look into the distance for 20 seconds.
- When your eyes get sore, close your eyes for a minute.

Using Low Blue Light

Decreasing the blue light emitting by the Interactive Flat panel display reduces the blue light exposure to your eyes.

The Interactive Flat panel display use a low blue light panel default setting mode, that when used in the default setting mode, is certified by TUV to reduce blue light output and create a more relaxing and less stimulating image while reading content on the screen.

The hardware solution was developed to control the blue light range emission. Instead of reducing the total blue range, the selected range reduction does not impact CCT and display color. It exposes users to less blue light emission while letting them enjoy good color on the display.

Flicker Free

The flicker phenomenon is that the screen continues to alternate between light and dark, that is, the screen is constantly flickering. Some flicker phenomenon may not be perceived by the human eye, but the eye will still respond to the flicker of the screen (iris will expand and contract according to changes in brightness).

To improve this phenomenon, we use DC dimming technology to improve it, and obtained the flicker free certification.

4.6.16 Google

Enter the **Google** submenu to sign in to your google account, set the account related services, including backup data, recovery data, etc.

You can sign in to your google account by the following method:

- On the Home page, slide right to enter the google login interface;
- Sign in to any one of google apps;
- Enter **Settings > Google** to sign in.

4.6.17 System

Enter the **System** submenu to see system version information and admin mode.

Menu	Setting	Functions
Languages & input	Set the language and keyboard	Language, app language, on-screen keyboard and physical keyboard can be chosen.
Gesture	Quick open camera	Switch ON/OFF
	System navigation	Gesture navigation, 3-button navigation can be chosen.
Date & Time	Set time automatically	Switch ON/OFF
	Select date format	Switch ON/OFF
Backup	Back up to google drive	Switch ON/OFF
Multiple users	Switch ON/OFF	Enable the function to share your tablet by adding new users. Each user has a personal space on your tablet. The icon  will appear on the lock screen page and quick setting menu when the function is enabled.

Menu	Setting	Functions
Multiple users	Owner	<p>Profile info: Tap to change owner icon and name.</p> <p>Owner import data: If you had more than two devices and would like to keep the setting as the same. You can put the export file into the USB disk and plug it into the USB port, then press the import option to import the setting you have done in the other device.</p> <p>Owner export data: If you had more than two devices and would like to keep the setting as the same. You can export the settings in the setting page. All the configuration setting will be exported as a file called 811config.jason.</p>
	Add User	<p>You can share this device with other people by creating additional users. Each user has their own space with customizable options such as apps, wallpapers and so on.</p> <p>Switch to new user: Tap to switch to other user or guest. Delete user: Delete the user account.</p> <p>User import: If you would like to keep the setting as the same. You can put the export file into USB disk and plug it into USB port, then press the import option to import the setting you have done in the other device. You can also import or export the settings of the same device. The settings of different users can be exported to each other.</p> <p>User export: If you would like to keep the setting as the same. You can export the settings on the setting page, all the configuration setting will be exported as a file called 811config.jason.</p>
	Add Guest	No password is required to access the system as a guest.
Reset options	Reset Wi-Fi, mobile & Bluetooth	Tap to reset all network settings.
	Reset App Preferences	Tap to reset all preferences.
	Factory Data Reset	Tap to erase all data.

Menu	Setting	Functions
Advanced	System update	Upgrade options are as follows: OTA, over the air update method and automatic updates.
	Security locks	Whiteboard and screenshot data removal frequency: you can set the time period of keep the data. When the set time is reached, the data is automatically cleared.
		USB lock: When you enable the USB lock, under the smart system, only USB disk will be locked, user will not be able to read the data from the USB disk, but USB mouse and keyboard could be used. Under the external source, all the USB devices will be blocked.
		Notes: Once the USB lock function is turned on, it will be effective for owner, all users and guest. Whether the owner, user or guest enters the system, the USB lock function is always valid.
		Installation lock: When you enable the Installation lock, under the smart system, you will not be able to install software through the app store or USB flash drive.
		Gadgets lock: All the installed application will be listed here, you can disable any gadgets you don't want to show in the gadgets list except whiteboard and settings.
		Settings lock: When you enable the setting lock, the setting-related icons will be displayed as locked, if you would like to do the setting, need to enter the admin mode and turn it off.
		Power button lock: When you enable the power button lock, the power button will be locked no matters on Android or any external sources.
		Front buttons lock: When you enable the front button lock, the front button will be locked no matters on Android or any external sources.
	Modify Admin Mode password	You can modify admin mode password in this interface, admin mode password consists of 16 letters or numbers.
Volume	The maximum volume was set at 10% increments	



Multiple Users Accounts

There are multiple user roles on the system, and the permissions for each role can be assigned as shown in the table below.



Functions	Admin	Owner	User	Guest
Capacity	1	1	No quantity limit	1
Password composition	≤16 digits	4 digits	4 digits	None
Enter advanced menu	2364606633	2364606633	No permission	No permission

How to create multiple users

The multiple users icon  will appear on the lock screen page and quick setting menu when the multiple users function is enabled, tap the icon to add roles and switch users. You can create account by the following method:

- Enter **Settings > System > Multiple users** to add users;
- Tap the  icon on the lock screen page to add users;
- Tap the  icon on the quick setting menu to add users.

How to switch accounts between multiple users

- Enter **Settings > System > Multiple users> switch** to new user;
- Tap the  icon on the lock screen page to switch users.
- Tap the  icon on the quick setting menu to switch users.

4.6.18 About Tablet

Enter the **About tablet** submenu to check the system info such as Model, serial number, system version, firmware version, IP address, MAC address...etc.

Menu	Functions
Device name	Display device name
Model	Display device model
RAM	Display the RAM of the device
Serial number	Display Serial number
Android version	Display Android version
Firmware version	Display Firmware version

Menu	Functions
IP address	Display IP address
Mac address	Display Mac address
Bluetooth address	Display Bluetooth address
Up time	Display the up time
Screen time	Tap to set the type of screen time, options included total screen time, daily screen time and weekly screen time.

5

Serial Port Control

RS232 communication cable (please use cross data cables)

PIN	This Device	Computer
1	NC	NC
2	RXD0	TXD0
3	TXD0	RXD0
4	NC	NC
5	GND	GND
6	NC	NC
7	NC	NC
8	NC	NC
9	NC	NC
Cover	GND	GND

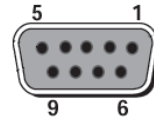

RS232 port of panel

There are multiple user roles on the system, and the permissions for each role can be assigned as shown in the table below.

Port: COM1 (Set according to PC or controlling product's port number)			
Baud rate	19200	Odd/even check	None
Data bits	8	Stop bit	1

• The following tables list controlling codes, querying codes and return codes.

Function	Controlling codes	Return codes
Power on	7F 08 99 A2 B3 C4 02 FF 01 00 CF	7F 09 99 A2 B3 C4 02 FF 01 00 01 CF
Power off	7F 08 99 A2 B3 C4 02 FF 01 01 CF	7F 09 99 A2 B3 C4 02 FF 01 01 01 CF
Mute/Unmute	7F 08 99 A2 B3 C4 02 FF 01 02 CF	7F 09 99 A2 B3 C4 02 FF 01 02 01 CF
Signal source	7F 08 99 A2 B3 C4 02 FF 01 06 CF	7F 09 99 A2 B3 C4 02 FF 01 06 01 CF

Function	Controlling codes	Return codes
Enable whiteboard	7F 08 99 A2 B3 C4 02 FF 01 07 CF	7F 09 99 A2 B3 C4 02 FF 01 07 01 CF
Display status	7F 08 99 A2 B3 C4 02 FF 01 09 CF	7F 09 99 A2 B3 C4 02 FF 01 09 01 CF
HDMI front / HDMI 1	7F 08 99 A2 B3 C4 02 FF 01 0A CF	7F 09 99 A2 B3 C4 02 FF 01 0A 01 CF
HDMI rear 1 / HDMI 2	7F 08 99 A2 B3 C4 02 FF 01 52 CF	7F 09 99 A2 B3 C4 02 FF 01 52 01 CF
HDMI rear 2 / HDMI 3	7F 08 99 A2 B3 C4 02 FF 01 53 CF	7F 09 99 A2 B3 C4 02 FF 01 53 01 CF
VGA / USB-C (Front)	7F 08 99 A2 B3 C4 02 FF 01 54 CF	7F 09 99 A2 B3 C4 02 FF 01 54 01 CF
USB-C (Rear)	7F 08 99 A2 B3 C4 02 FF 01 55 CF	7F 09 99 A2 B3 C4 02 FF 01 55 01 CF
Internal PC	7F 08 99 A2 B3 C4 02 FF 01 38 CF	7F 09 99 A2 B3 C4 02 FF 01 38 01 CF
DP	7F 08 99 A2 B3 C4 02 FF 01 56 CF	7F 09 99 A2 B3 C4 02 FF 01 56 01 CF
Page up	7F 08 99 A2 B3 C4 02 FF 01 13 CF	7F 09 99 A2 B3 C4 02 FF 01 13 01 CF
Page down	7F 08 99 A2 B3 C4 02 FF 01 14 CF	7F 09 99 A2 B3 C4 02 FF 01 14 01 CF
VOL -	7F 08 99 A2 B3 C4 02 FF 01 17 CF	7F 09 99 A2 B3 C4 02 FF 01 17 01 CF
VOL +	7F 08 99 A2 B3 C4 02 FF 01 18 CF	7F 09 99 A2 B3 C4 02 FF 01 18 01 CF
Menu	7F 08 99 A2 B3 C4 02 FF 01 1B CF	7F 09 99 A2 B3 C4 02 FF 01 1B 01 CF
Home page	7F 08 99 A2 B3 C4 02 FF 01 1C CF	7F 09 99 A2 B3 C4 02 FF 01 1C 01 CF
Return (exit)	7F 08 99 A2 B3 C4 02 FF 01 1D CF	7F 09 99 A2 B3 C4 02 FF 01 1D 01 CF
OK	7F 08 99 A2 B3 C4 02 FF 01 2B CF	7F 09 99 A2 B3 C4 02 FF 01 2B 01 CF
←	7F 08 99 A2 B3 C4 02 FF 01 2C CF	7F 09 99 A2 B3 C4 02 FF 01 2C 01 CF
→	7F 08 99 A2 B3 C4 02 FF 01 2D CF	7F 09 99 A2 B3 C4 02 FF 01 2D 01 CF
↑	7F 08 99 A2 B3 C4 02 FF 01 2E CF	7F 09 99 A2 B3 C4 02 FF 01 2E 01 CF

Function	Controlling codes	Return codes
↓	7F 08 99 A2 B3 C4 02 FF 01 2E CF	7F 09 99 A2 B3 C4 02 FF 01 2E 01 CF
Set volume	7F 08 99 A2 B3 C4 02 FF 05 XX CF	7F 09 99 A2 B3 C4 02 FF 05 XX 01 CF
Query the firmware version number	7F 08 99 A2 B3 C4 02 FF 01 3D CF	7F 09 99 A2 B3 C4 02 FF 01 3D XX CF Note: XX indicates version (20211110183518)F
Set display mode	7F 08 99 A2 B3 C4 02 FF 06 XX CF	7F 09 99 A2 B3 C4 02 FF 06 XX 01 CF
Enable the annotation function	7F 08 99 A2 B3 C4 02 FF 01 40 CF	7F 09 99 A2 B3 C4 02 FF 01 40 01 CF
Increase backlight brightness	7F 08 99 A2 B3 C4 02 FF 01 47 CF	7F 09 99 A2 B3 C4 02 FF 01 47 01 CF
Decrease backlight brightness	7F 08 99 A2 B3 C4 02 FF 01 48 CF	7F 09 99 A2 B3 C4 02 FF 01 48 01 CF
Set the value of backlight brightness	7F 08 99 A2 B3 C4 02 FF 09 XX CF	7F 09 99 A2 B3 C4 02 FF 09 XX 01 CF
Switch backlight	7F 08 99 A2 B3 C4 02 FF 01 15 CF	7F 09 99 A2 B3 C4 02 FF 01 15 XX CF
Switch to screen lock	7F 08 99 A2 B3 C4 02 FF 01 57 CF	7F 09 99 A2 B3 C4 02 FF 01 57 01 CF
Screenshot	7F 08 99 A2 B3 C4 02 FF 01 1F CF	7F 09 99 A2 B3 C4 02 FF 01 1F 01 CF
Settings	7F 08 99 A2 B3 C4 02 FF 01 20 CF	7F 09 99 A2 B3 C4 02 FF 01 20 01 CF
Freeze ON/OFF toggle	7F 08 99 A2 B3 C4 02 FF 01 3B CF	7F 09 99 A2 B3 C4 02 FF 01 3B 01 CF
Freeze On	7F 09 99 A2 B3 C4 02 FF 0B 00 CF	7F 09 99 A2 B3 C4 02 FF 0B 00 01 CF
Freeze Off	7F 09 99 A2 B3 C4 02 FF 0B 01 CF	7F 09 99 A2 B3 C4 02 FF 0B 01 01 CF

Function	Controlling codes	Return codes
Mute On	7F 09 99 A2 B3 C4 02 FF 0F 00 CF	7F 09 99 A2 B3 C4 02 FF 0F 00 01 CF
Mute Off	7F 09 99 A2 B3 C4 02 FF 0F 01 CF	7F 09 99 A2 B3 C4 02 FF 0F 01 01 CF
Switch Safety Lock On	7F 09 99 A2 B3 C4 02 FF 0D 01 CF	7F 09 99 A2 B3 C4 02 FF 0D 01 01 CF
Switch Safety Lock Off	7F 09 99 A2 B3 C4 02 FF 0D 00 CF	7F 09 99 A2 B3 C4 02 FF 0D 00 01 CF
Switch Backlight On	7F 09 99 A2 B3 C4 02 FF 0E 01 CF	7F 09 99 A2 B3 C4 02 FF 0E 01 01 CF
Switch Backlight Off	7F 09 99 A2 B3 C4 02 FF 0E 00 CF	7F 09 99 A2 B3 C4 02 FF 0E 00 01 CF
Set Display message on the OSD	7F 09 99 A2 B3 C4 02 FF 1A XX CF	7F 09 99 A2 B3 C4 02 FF 1A 00 XX CF NOTE: XX indicates the value of text content up to 50 characters. ● XX = 01 indicates set OSD OK. ● XX = 00 indicates set OSD failed.

Function	Querying codes	Return codes
Power supply	7F 08 99 A2 B3 C4 02 FF 01 37 CF	7F 09 99 A2 B3 C4 02 FF 01 37 XX CF Notes: XX indicates the power on/off state. XX = 01: power on state; XX = 00: power off state.
Speaker	7F 08 99 A2 B3 C4 02 FF 01 82 CF	7F 09 99 A2 B3 C4 02 FF 01 82 XX CF Notes: 01: mute; 00: non-mute.

Function	Querying codes	Return codes
Current signal source	7F 08 99 A2 B3 C4 02 FF 01 50 CF	7F 09 99 A2 B3 C4 02 FF 01 50 XX CF Notes: <ul style="list-style-type: none"> • Smart system = 30 • PC = 17 • DP = 20 • HDMI Front (1) = 19 • HDMI Rear 1 (2) = 1F
Speaker volume	7F 08 99 A2 B3 C4 02 FF 01 33 CF	7F 09 99 A2 B3 C4 02 FF 01 33 XX CF Notes: XX indicates current volume value (XX is a hexadecimal value, range: 00~64). For example, XX = 20 indicates current volume value is 32 (decimal value), XX = 00 indicates mute state.
D.Mode	7F 08 99 A2 B3 C4 02 FF 01 35 CF	7F 09 99 A2 B3 C4 02 FF 01 35 XX CF Notes: XX indicates the mode. XX = 00-standard; XX = 01-ECO mode; XX = 02-custom; XX = 03-auto.
Backlight brightness	7F 08 99 A2 B3 C4 02 FF 01 49 CF	7F 09 99 A2 B3 C4 02 FF 01 49 XX CF Notes: XX indicates the value of backlight brightness (0 - 100), corresponding to the hexadecimal number system (00 - 64).
Backlight status	7F 08 99 A2 B3 C4 02 FF 01 81 CF	7F 09 99 A2 B3 C4 02 FF 01 81 XX CF Notes: XX = 00 indicates the backlight is on. XX = 01 indicates the backlight is off.
Screen lock status	7F 08 99 A2 B3 C4 02 FF 01 84 CF	7F 09 99 A2 B3 C4 02 FF 01 84 XX CF Notes: XX = 01 indicates the child safety lock is on. XX = 00 indicates the child safety lock is off.

Function	Querying codes	Return codes
Whiteboard state	7F 08 99 A2 B3 C4 02 FF 01 83 CF	7F 09 99 A2 B3 C4 02 FF 01 83 XX CF Notes: XX = 01 indicates the whiteboard state. XX = 00 indicates non-whiteboard state.
Return to system state of the previous options	7F 08 99 A2 B3 C4 02 FF 0A 00 CF	7F 08 99 A2 B3 C4 02 FF 0A 00 AB CD EF GH IJ OP QR ST UV CF Notes: AB: Power supply; CD: Speaker; EF: Current signal source; GH: Speaker volume; IJ: D.Mode; OP: Backlight brightness; QR: Backlight state; ST: Whiteboard state; UV: Screen lock state.

6

FAQs & Troubleshooting

Symptom	Troubleshooting Methods
The screen cannot be powered on or the power indicator light is off.	<ul style="list-style-type: none"> • Check whether the power supply is connected. • Check whether the power supply plug is properly connected. • Check whether the power outlet has electricity. • Check whether the rocker switch is enabled. • Press the reset switch and start the system again.
The remote control is not causing a response.	<ul style="list-style-type: none"> • Replace the batteries. • Check whether the polarity direction of the batteries is correct. • Align the remote control with the IR receiver window. For details, see section "Remote Control".
The image is normal but there is no sound.	<ul style="list-style-type: none"> • Increase volume on both the screen and the Windows system. • Check whether the screen and the Windows system are muted. • If an external computer is connected, check whether the connection cables are normal.
The system is automatically powered on/off when no operation is being performed.	<ul style="list-style-type: none"> • Disable the automatic power-on/off function. For details, see section "Power ON/OFF Setting". • Check whether the screen entered shut down mode due to no operation for an extended period of time. • Check whether the input power supply is stable.
The colors of images are abnormal.	Check whether the HDMI cable is properly connected or has any quality issue.
The touch function is abnormal or the positioning is inaccurate.	<ul style="list-style-type: none"> • Restart the screen. • In the Windows system, recalibrate the screen. For details, see section "Calibration".
The touch function is unavailable when the external signal source channel is being used.	<ul style="list-style-type: none"> • Switch between different external signal sources. • Ensure that the USB touch cable is connected to the proper port. For details, see section "Ports". • Remove and insert the USB touch cable again.
There is no sound when the HDMI in channel is used.	Remove and insert the HDMI cable again.

Symptom	Troubleshooting Methods
No image is displayed when the HDMI out channel is used.	<ul style="list-style-type: none"> • Generally, this issue is caused by the compatibility of the external display product. Replace the external display product and test again. • The HDMI cable is too long or has a poor quality. Replace the HDMI cable delivered with the product.
The touch function on the front panel is ineffective.	<ul style="list-style-type: none"> • Touch the button using your full fingertip. • Check whether the finger is wet or has other liquids on it. • Restart the screen.
The USB flash drive cannot be identified.	Check whether the USB flash drive is inserted into the correct USB port. For details, see section "Ports."
The conference records cannot be saved on the USB flash drive, and the system prompts "The target storage product has no write permissions."	Format the USB flash drive to the FAT32 format.
The OPS has no signal.	<ul style="list-style-type: none"> • Check whether the OPS is properly inserted in the slot. • Check whether the OPS is in shut down mode. • Press the power button on the OPS (for details, see the instructions of the OPS), and manually start up the OPS.
In the embedded operating system or Windows system, no wireless network can be found or the wireless network signal is weak.	Check whether the Wi-Fi antenna is properly installed on the embedded operating system. For details, see section "Ports".
	Check whether the Wi-Fi antenna is properly installed for the OPS.

7

Specifications

Model	TT-5523QA	TT-6523QA	TT-7523QA	TT-8623QA	TT-9823QA
Display					
Backlight	LED				
Display Area	47.64 x 26.77 in/ 1210 x 680mm	56.22 x 31.61 in/1428 x 803mm	64.96 x 36.54 in/1650 x 928mm	74.60 x 41.97 in/1895 x 1066mm	85.16 x 48.07 in/2163 x 1221mm
Active Screen Size	55 inch	65 inch	75 inch	86 inch	98 inch
Display Ratio	16:9				
Resolution	3840 x 2160 Pixel				
Display Colors	1.07 billion colors				
Brightness	≥ 400 cd/m ²				
Contrast	Dynamic 5000:1				
Response Time	≤ 8 ms				
Life Time	≥50000 h (Min.)				
Speaker					
Speaker Position	Bottom Front				
Max. Power Output	2 x 20 W				
Microphone					
Type	3.5 mm interface				

Model	TT-5523QA	TT-6523QA	TT-7523QA	TT-8623QA	TT-9823QA
Electrical					
Power Consumption	Maximum ≤ 550 W Standby Mode ≤ 0.5 W	Maximum ≤ 550 W Standby Mode ≤ 0.5 W	Maximum ≤ 620 W Standby Mode ≤ 0.5 W	Maximum ≤ 650W Standby Mode ≤ 0.5 W	Maximum ≤ 800 W Standby Mode ≤ 0.5 W
Working Voltage	AC 100 V – 240 V, 50 Hz / 60 Hz				
Touch					
Touch Surface	Anti-Glare + Anti-Fingerprint + Antimicrobial Tempered Glass				
Transparency	88%±3%				
Touch Points	Android 20 points, Windows 40 points				
Writing Tools	Eraser, Stylus or Finger				
Scan Speed	≤10ms				
Communication Interface	USB-A				
Transportation/Storage					
Storage Temperature/ Humidity	-20~60°C/0~90%RH (non-condensing)				
Working Temperature/ Humidity	0°C-40°C/20~80%RH(Non coagulation)				
Mounting (optional)	Wall-mounted/Mobile Stand				
Outline Dimension	1294 x 806 x 96mm	1513 x 927 x 118mm	1735 x 1051 x 119mm	1981 x 1191 x 119mm	2258 x 1354 x 122mm
Packing Dimension	1414 x 915 x 185mm	1640 x 1030 x 185 mm	1859 x 1160 x 205 mm	2119 x 1290 x 228 mm	2370 x 1484 x 356 mm
Net Weight	approx. 29.5kg	approx. 39kg	approx. 51kg	approx. 63kg	approx. 108kg

Model	TT-5523QA	TT-6523QA	TT-7523QA	TT-8623QA	TT-9823QA
Gross Weight	38kg	48.5kg	64.5kg	80kg	147±1kg
Ports					
Front Interface Inputs	HDMI In x 1, USB (Touch) x 1, USB 3.0 x 2, Microphone In x 1, Type C x 1				
Rear Interface Inputs	RS232 x 1, Line Out x 1, SPDIF Out x 1, HDMI Out x 1, Android USB 3.0 x 1, LAN IN x 1, LAN OUT x 1, Battery x 1 DP x 1, USB3.0 (Touch) x 3, USB 3.0 (Public) x 2, Type C x 1, HDMI 2(ARC) In x 1, HDMI 3 In x 1, OPS Slots (4K@60Hz)				
Other functions					
Intelligent thermos protector	Yes				
Smart System					
Andriod version	Andriod 13				
RAM	8G				
Flash	128GB (Onboard 64GB + SD Card 64GB)				
Multimedia File Formats	Image: BMP, JPG, PNG, GIF, WEBP Video: H.263, MJPEG, MPEG1, MPEG2, AVC(H264), VP8, VP9, Motion JPEG, HEVC, 4K HEVC(4K H265) Audio: MPEG1/2, MPEG1/2 LAYER2, MPEG1/2/2.5 LAYER3, AAC, AVORBIS, VORBIS, LPCM, FLAC, OPUS, MP2, MP3				
Pre-installed applications	Refer to the actual panel display				
Firmware Version	V456				
Wi-Fi Module					
Parameters	Wi-Fi 6 +BT 5.2				
Camera Module (Optional)					
Camera Resolution	4K@ 30 Hz /UHD				

Model	TT-5523QA	TT-6523QA	TT-7523QA	TT-8623QA	TT-9823QA
Field of View	120° FOV Lenses				
Resolution	8M				
Camera Tile Range	15°				

 Note

- For TT-5523QA, TT-6523QA, TT-7523QA and TT-8623QA, Manufacturer-reported maximum luminance LMax Reported is 400cd/m².
- For TT-9823QA, Manufacturer-reported maximum luminance LMax Reported is 420cd/m².

8

More Information

For more information

Please visit our website (www.newline-interactive.com) for detailed instruction manual.

Contact Us for Support

Please email us at support@newline-interactive.com.

Our company is devoted to product innovation and technology enhancement. Therefore, we may change product specification and information without notice. Product pictures in the manual are for reference only, please refer to actual products.